

AMPERO III

CDCM HD Gen 2 Amp Modeler / Effects Processor

User Manual

For Firmware V1.0.2

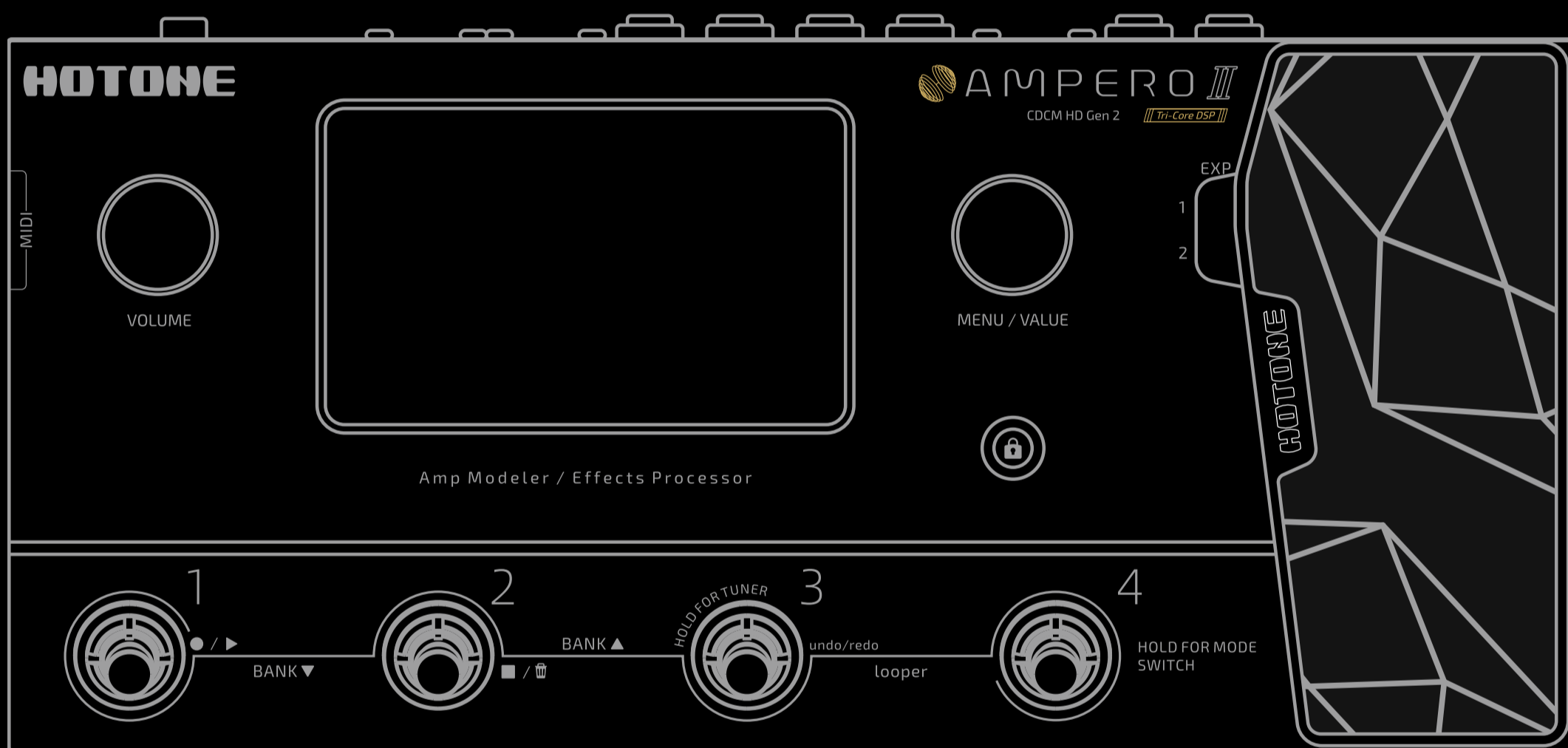

HOTONE
DESIGN INSPIRATION

※In the interest of product improvement, the specifications and/or the content of products (including but not limited to appearances, packaging design, manual content, accessories, size, parameters and display screen), are subject to change without prior notice. Please check with local supplier for exact offers. Specifications and features (including but not limited to appearances, colors and size) may vary by model owing to environmental factors, and all images are illustrative.

Contents

Welcome	1
Safety Instructions	2
Precautions	2
Definition of intended use	2
Definitions	7
Panel	9
Front	9
Top	11
Getting Started	13
Using the Interface	15
Unit Mode and Main Display	17
Patch Mode	18
Stomp Mode (FX Chain View)	19
Stomp Mode (Footswitch View)	20
Tuner	22
Looper	23
Drum	26
Bypass	27
Customizing Your Unit	28
Edit A Patch	28
Effects Chain Basics	28
Input Node Setup	31
Output Node Setup	33
Effects Chain Types	34
Split/Mixer Node Settings	36
Effects Chain Templates	39
Slots and Modules Settings	40
Effects Settings	43
Using FX Loop	46
Patch Tempo and Volume	50
Scenes	50

Patch Settings	51
FS Settings	52
Quick Access Para	54
Patch MIDI	55
EXP 1-3 Settings	55
SAVE	57
Patch Management	58
GLOBAL	61
I/O	61
USB Audio	64
Advanced USB Audio Interface Function Guide	66
Setting the USB Audio Sample Rate for the Ampero II	68
Controls	69
MIDI Settings	73
Global EQ	74
Display	76
Bluetooth	77
About	78
Factory Reset	78
Suggested Setups	80
Using with your instrument and amp	80
Connecting to your amp's RETURN or Power Amp (Loudster)/ FRFR cabinet INPUT	81
On-stage dual outputs	82
Singer performing with instruments	83
Connecting your mixer, interface, headphones, and other equipment	84
Connecting to your computer as an audio interface	85
Using Bluetooth audio and AUX IN	86
The Editor	87
Troubleshooting	88
Technical Specifications	90

» Welcome

Thank you for purchasing a Hotone product.
Please read this manual carefully to get the most out of your Ampero II.
Please keep this manual in a safe place for further reference.

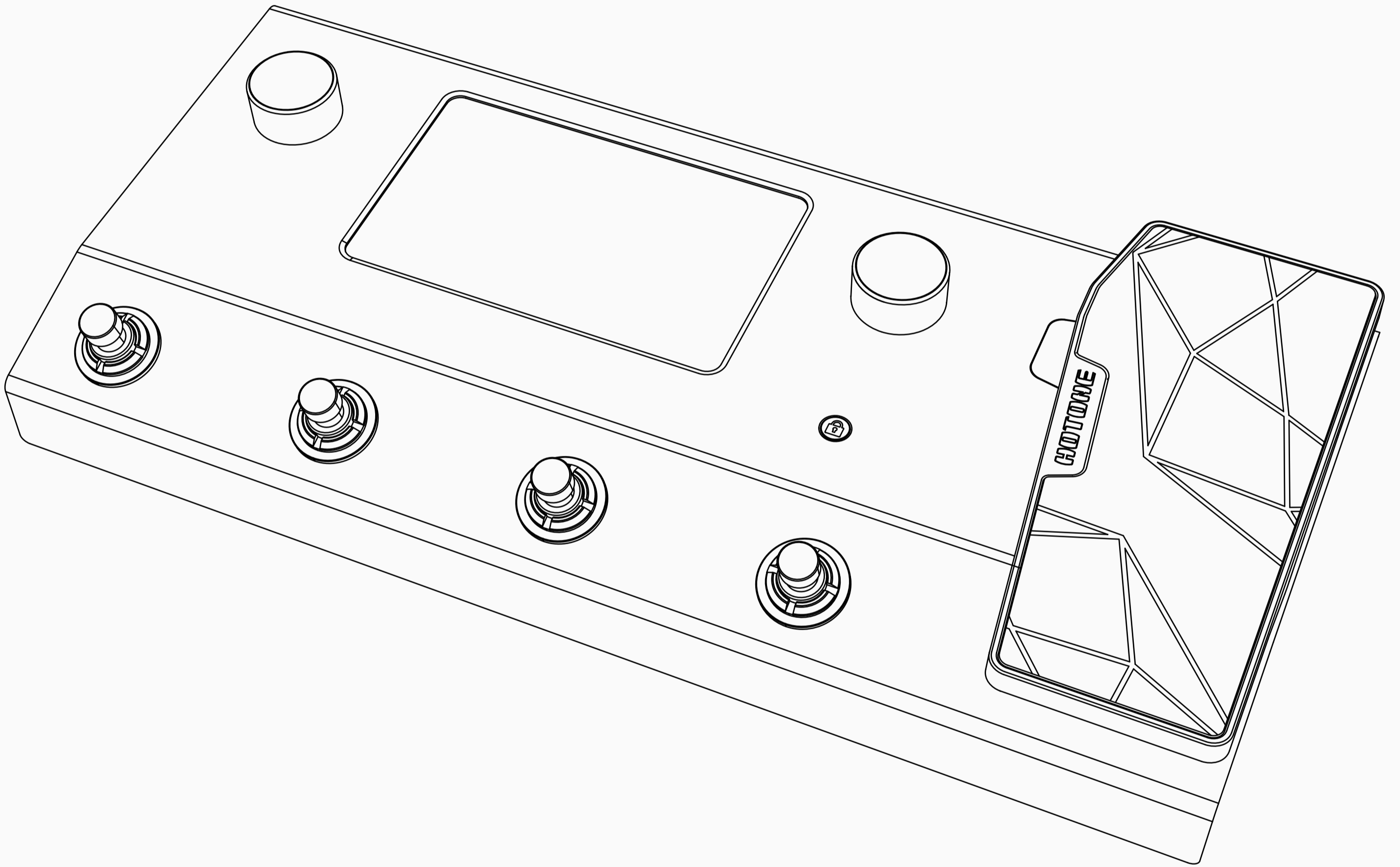

» Safety Instructions

Precautions

PLEASE READ CAREFULLY BEFORE OPERATING THE DEVICE.

Please keep this manual in a safe place for future reference.

Please always follow the basic precautions listed below.

These precautions include, but are not limited to, the following:

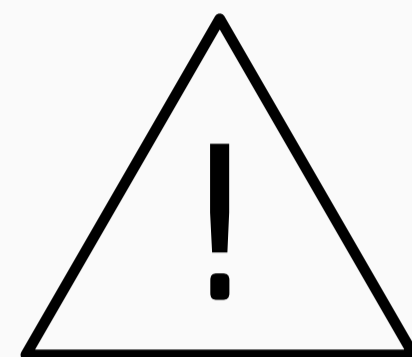

Definition of intended use

Power supply & power cord

Please check the voltage specification on the device or device power adaptor match your power supply network.

Please be sure to use the device just with an adequate power supply, such as original supplied power adaptor.

When using a 3rd party power adapter, please make sure the power adapter fits the device's power requirement. Use of an adapter other than that specified could damage the unit or cause malfunction and pose a safety hazard, such as incorrect polarity would cause the fire hazard.

Hotone will not be responsible for physical injury to you or others, or damage to the device or other property.

When disconnecting the adapter from an outlet, please always pull the connector itself. Pulling the cord will cause damage to the unit.

Make sure to separate the power adapter and store in a safe place.

Please remove the electric plug from the outlet when the device is not to be used for extended periods of time, or during electrical storms.

Please be sure to connect to an appropriate outlet with a protective grounding connection.

Do not open

This device contains no user-serviceable parts. Do not open the device or attempt to disassemble the internal parts or modify them in any way.

Opening the case may expose you to dangerous voltages, or other hazards. Opening the casing or performing self-repairs on this device will result in the loss of the warranty eligibility for this device.

If it should appear to be malfunctioning, please discontinue use immediately and contact our service team.

Water warning

Do not expose the device to rain, use it near water or in damp or wet conditions, or place on it any containers (such as vases, bottles or glasses) containing liquids which might spill into any openings. If any liquid such as water seeps into the device, turn off the power immediately and unplug the power cord from the AC outlet.

Please never insert or remove an electric plug with wet hands.

Fire warning

Please do not place any burning items or open flames near the device, since they may cause a fire hazard.

Electromagnetic fields warning

Please avoid operating the device within significant electromagnetic fields. Failing to do so may result in noise, device malfunction, or even loss of data etc.

Hearing loss

Please avoid setting all volume levels to their maximum, specially with using headphones. Depending on the condition of the connected devices, doing so may result in feedback that can cause hearing loss and damage the speakers or headphones.

Before connecting the device to other devices, please turn off the power

for all devices. Also, before turning the power of all devices on or off, please make sure that all volume levels are set to the minimum. Failing to do so may result in hearing loss, electric shock, or device damage.

Location

Please keep away from children, or be accompanied by an adult. The following may cause choking hazard.

- Swallowing of small parts.
- Plastic covers and other packaging material.

While using, please do not cover the device with any cloth, or block any jack of the device.

The device and power supply will become warm with extended use.

Please avoid using the device in any of the following conditions that could cause malfunction:

- Extremely hot or cold places
- Sandy or dusty places
- Contact with corrosive gases or salt air
- Places with extreme vibrations

Before moving the device, please be sure to remove all connected cables, and power adaptor.

Depending on the material and temperature of the surface on which you place the device, its rubber feet may discolor or mar the surface.

Maintenance

Please remove the power plug from the AC outlet while cleaning the device.

Please use a soft cloth to clean the panels if they become dirty. If necessary, slightly moisten the cloth.

Never use cleansers, wax, or solvents such as paint thinner, benzene or alcohol.

Operation

Please do not apply excessive force to the knobs, switches, jacks, and other controls.

Please do not apply excessive force to the screen (if applicable) or casing, which may cause malfunction.

Please do not expose the unit to strong impact or drop it.

Please do not place foreign objects (liquid or solid) into the device.

Malfunction

If any of the following problems occur, immediately turn off the device and disconnect the electric plug from the outlet.

- The device is dropped or damaged.
- The power cord or plug becomes frayed or damaged.
- The power adaptor malfunction.
- Unusual smells or smoke are emitted.
- Some object has been dropped into the device.
- There is a sudden loss of sound during use of the device.
- Cracks or other visible damage appear on the device.
- The device has other obvious signs of malfunction (e.g. can not turn on, knobs can not work, volume is too low, etc.)

Then please contact our service team.

About disposal

While disposing of this product, please take them to applicable collection points, for proper treatment, in accordance with your national legislation.

Disposal of the packaging material



For the transport and protective packaging, environmentally friendly materials have been chosen that can be supplied to normal recycling.

Ensure that plastic bags, packaging, etc. are properly disposed of.

Please do not just dispose of these materials with your normal household waste, but make sure that they are collected for recycling.

Disposal of your old device



This symbol on the products, packaging, and/or accompanying documents means that used electrical and electronic products should not be mixed with general household waste.

By disposing of these products correctly, you will help to save valuable resources and prevent any potential negative effects on human health and the environment which could otherwise arise from inappropriate waste handling.

For more information about collection and recycling of old products, please contact your local municipality, your waste disposal service or the point of sale where you purchased the items.

This product is subject to the European Waste Electrical and Electronic Equipment Directive (WEEE Directive - Waste Electrical and Electronic Equipment) as amended from time to time version.



Observe the disposal note for documentation in France.

Disposal of batteries



Batteries must not be discarded or incinerated, but disposed of in accordance with local hazardous waste disposal regulations.

Service Contact

Please prepare information including the model name, serial number, specific symptoms related to the malfunction, your name, address and telephone number, etc.

You can contact the store where you bought the device, or contact Hotone support (service@hotoneaudio.com)

Please use this device according to the manual provided. Any other use, as well as use under other operating conditions, is considered improper use. Hotone cannot be held responsible for damage caused by improper use or modifications to the device.

» Definitions

● Effects Chain

The effects chain (or simply “chain”) shows the current internal signal routing/effect procession including current effects chain type, signal routing, current effects and effects combination, etc.

Ampero II features two effects chains with flexible serial/parallel options.

● Effect Slot

Effect slots (or simply “slots”) are spaces located on an effects chain for adding effects. Ampero II features 6 slots on one effects chain, 12 slots in total.

● Module

Ampero II employs 13 kinds of effects, each kind is called an “effects module,” or simply “module”. There are several effects available in each module. To use an effect, add a module to an empty effect slot, and then pick one effect in the module.

There are also some modules used for signal routing only.

● Parameter

Variables that determine the application of an effect are called “parameters”. If we imagine each slot as a separate effect pedal, then each parameter would be a knob on that pedal.

● Node

The beginning/end of an effects chain or the intersection of two effects chains is called a “node”:

Input node is the beginning of an effects chain that sets signal input source;

Output node is the end of an effects chain that determines where the signal goes;

Split node splits one effects chain into two, sending the signal to two effects chains;

Mixer node combines two effects chains into one.

- **Patch**

The ON/OFF status and current module/effect of each effect slot, parameter settings and related controller/expression pedal settings are stored in units called “patches”. These are your “tones.” Use patches to recall, edit, and save your favorite tones.

- **Scene**

A scene is a “patch within a patch” which helps you hold different effect parameter combinations and module on/off statuses in current patch. You can use scene function for gap free effect switching or natural delay/reverb trail spillovers during live performance.

- **Bank**

A set of 4 patches is called a “bank”. Ampero II has a total of 75 banks, which means, you have up to 300 fully editable/savable patches.

» Panel

Front

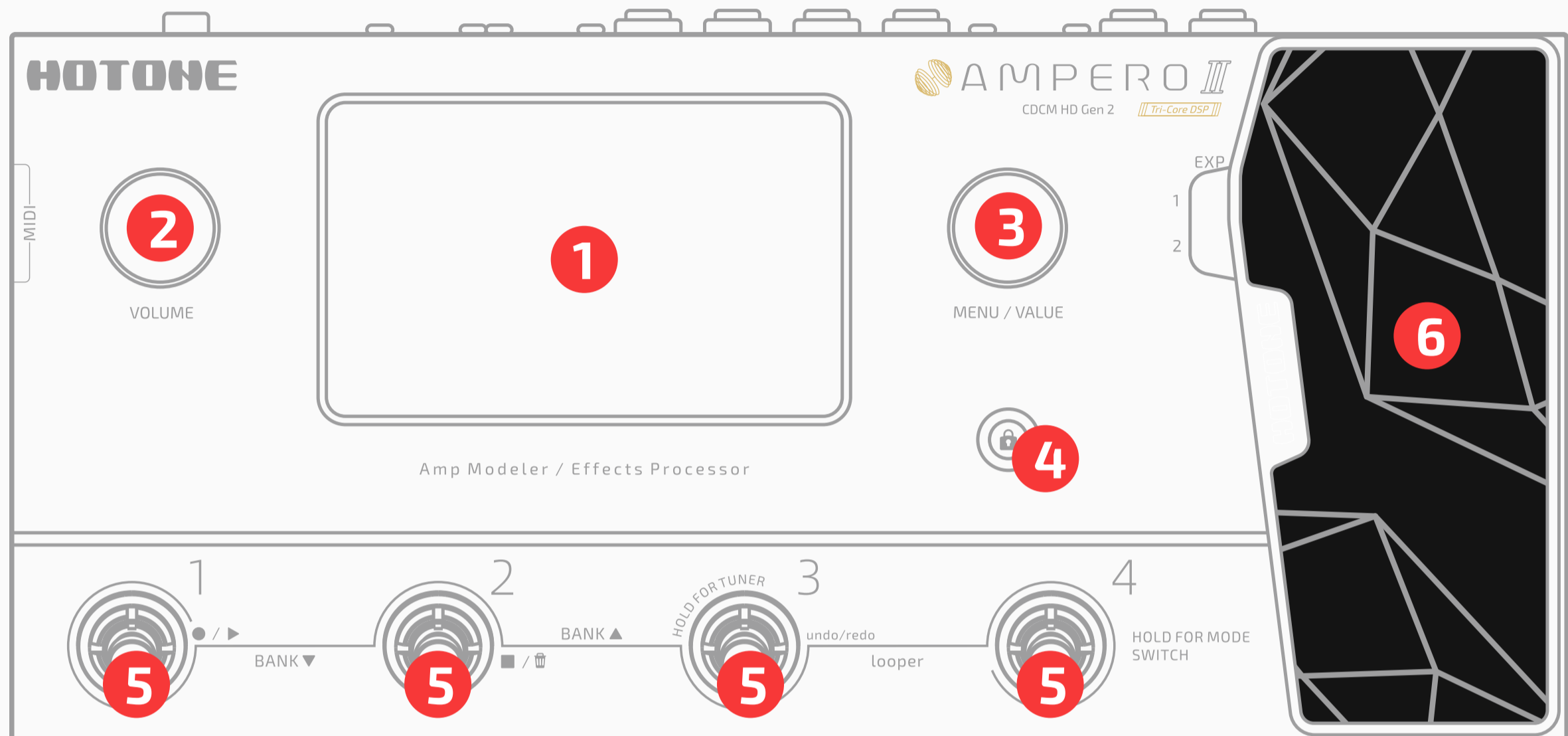

- 1. Display Screen:** Displays unit current status. Use the touchscreen to select effects, edit patches, and make tone adjustments.
- 2. Volume Knob:** Turning this knob allows you to adjust unbalanced/balanced (along with headphones output)/AUX audio (appears when connected) output volume, press to switch between control targets:

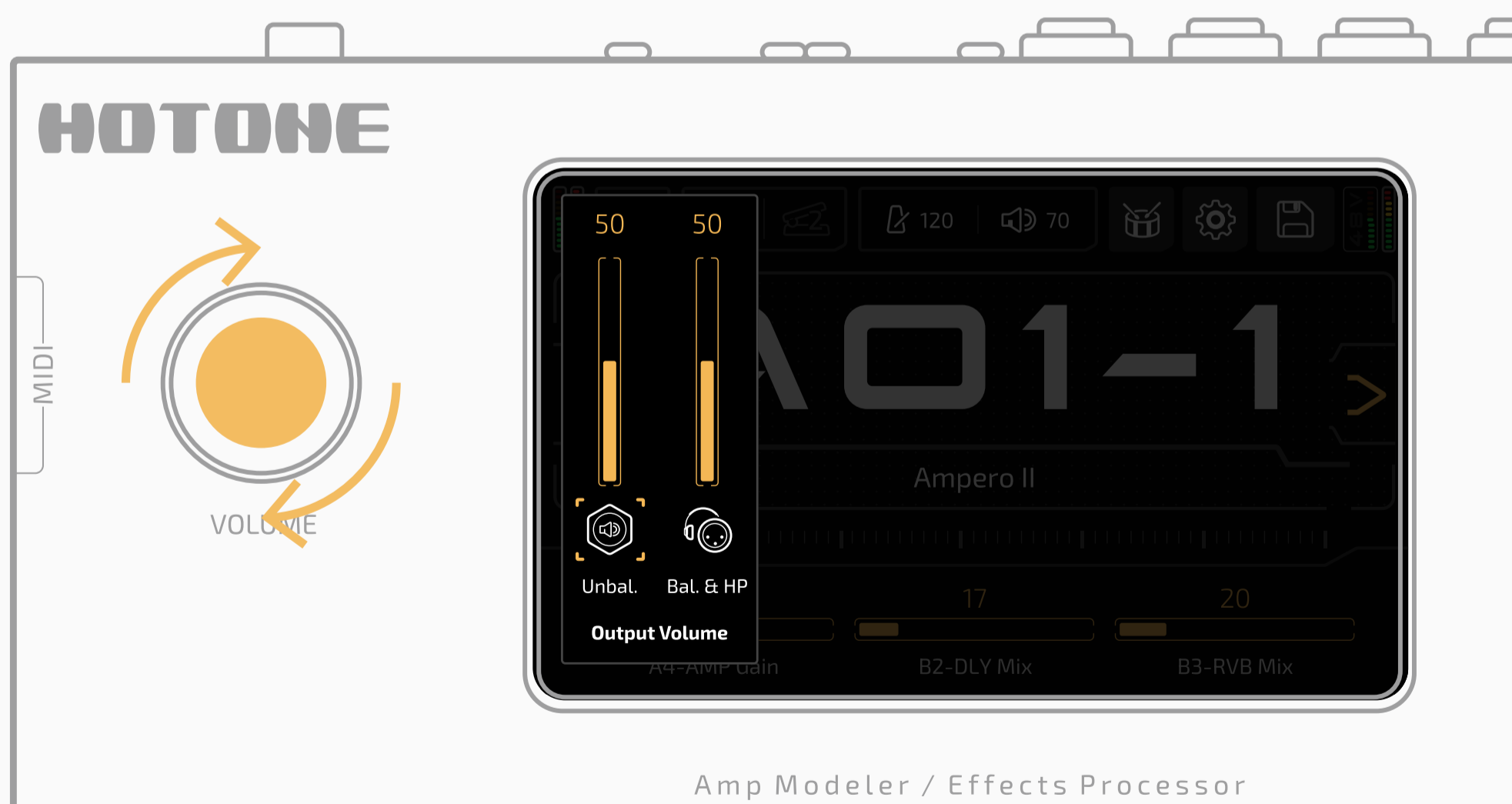

Turn to adjust selected output volume

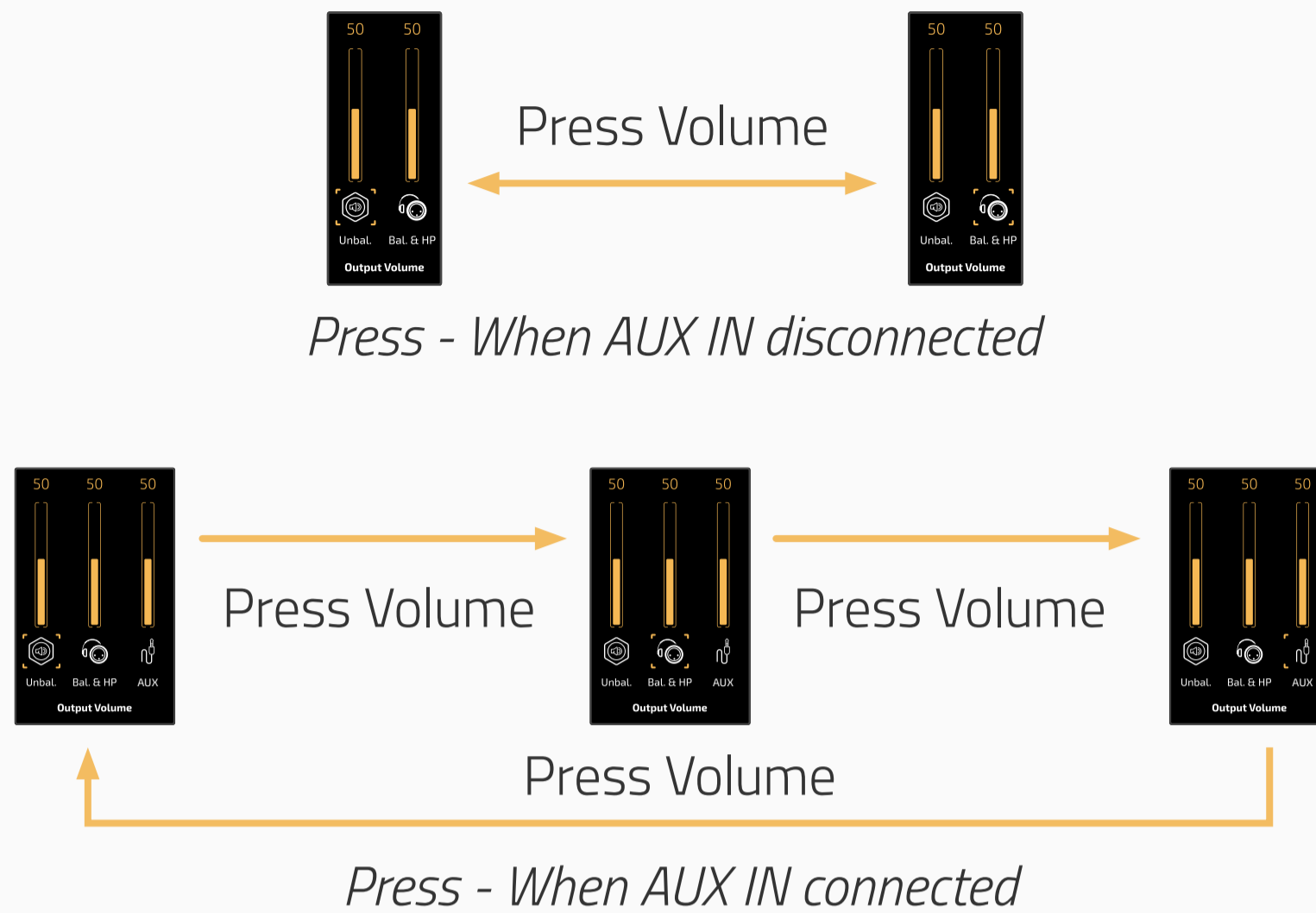

- 3. MENU/VALUE Knob (Main Knob):** Turning or pressing this knob allows you to change menus and adjust parameters.
- 4. Screen Lock Button:** Use to lock or unlock the touchscreen.
- 5. Programmable Footswitch:** Use to change patches/scenes, turn on/off effects, set tap tempo, etc.
- 6. Expression Pedal:** Use to control the parameter of one or several effects, including output volume. Press the pedal toe strongly to switch the EXP status.

Top

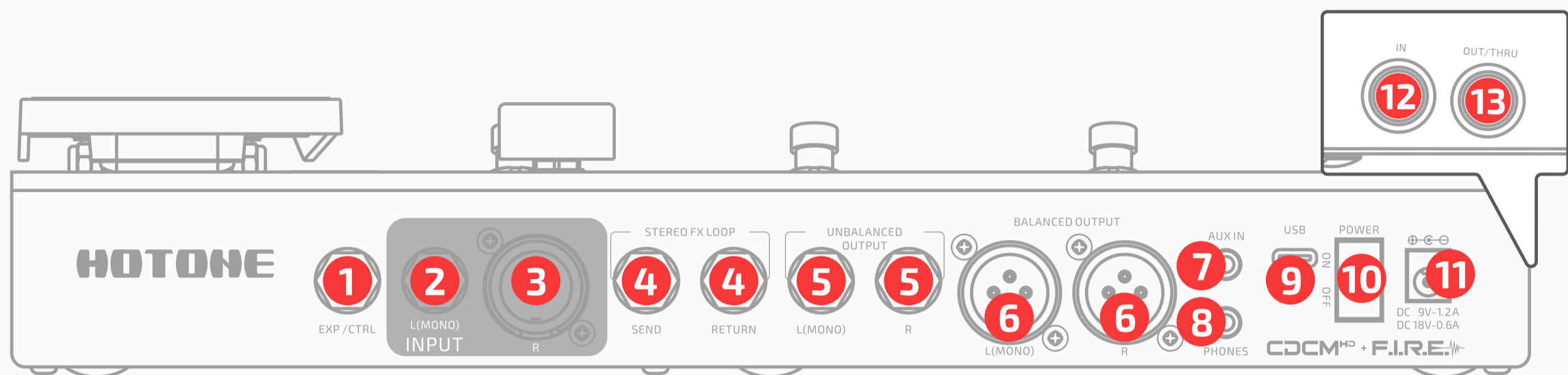

1. **EXP/CTRL:** 1/4" (6.35mm) TRS input, for connecting external expression pedals/momentary footswitch controllers. Perfect for Ampero Press or Ampero Switch+.
2. **INPUT L:** 1/4" (6.35mm) unbalanced input connection for guitar or other instruments
3. **INPUT R:** XLR/TS combo input for instruments or microphones.
4. **STEREO FX LOOP:** 1/4" (6.35mm) unbalanced stereo TRS input/output connections:
 - **SEND:** 1/4" (6.35mm) unbalanced stereo TRS output jack, for feeding signal to other devices
 - **RETURN:** 1/4" (6.35mm) unbalanced stereo TRS input jack, for receiving signal from other devices

When you need stereo connection, a Y cable is needed for connector separation/combination:

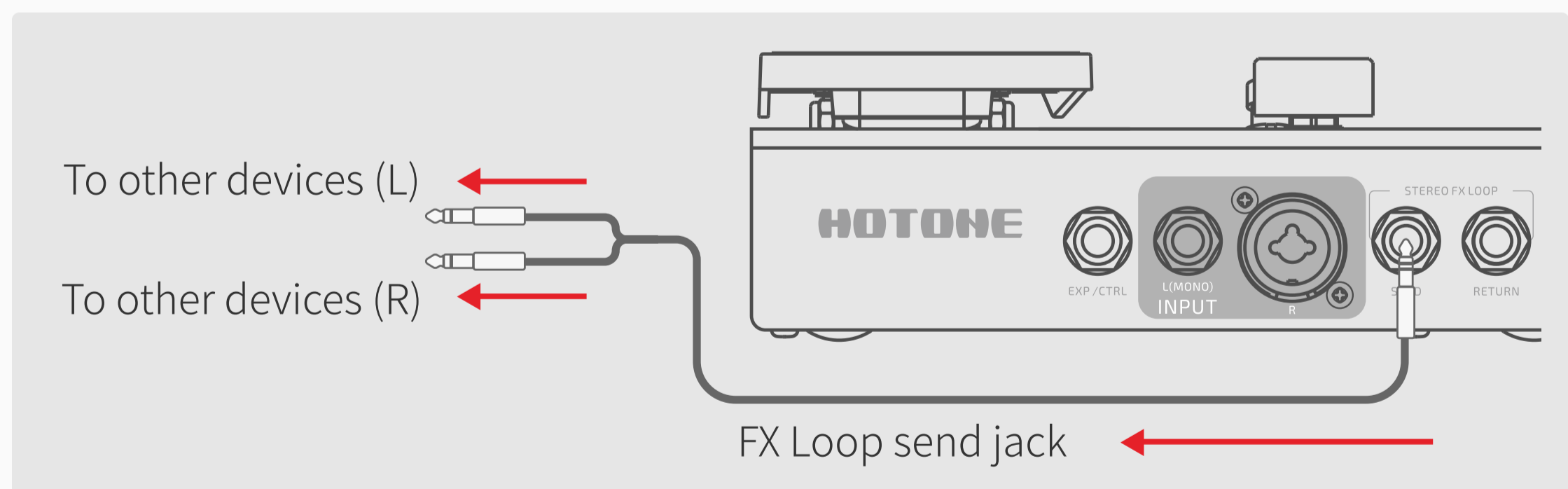

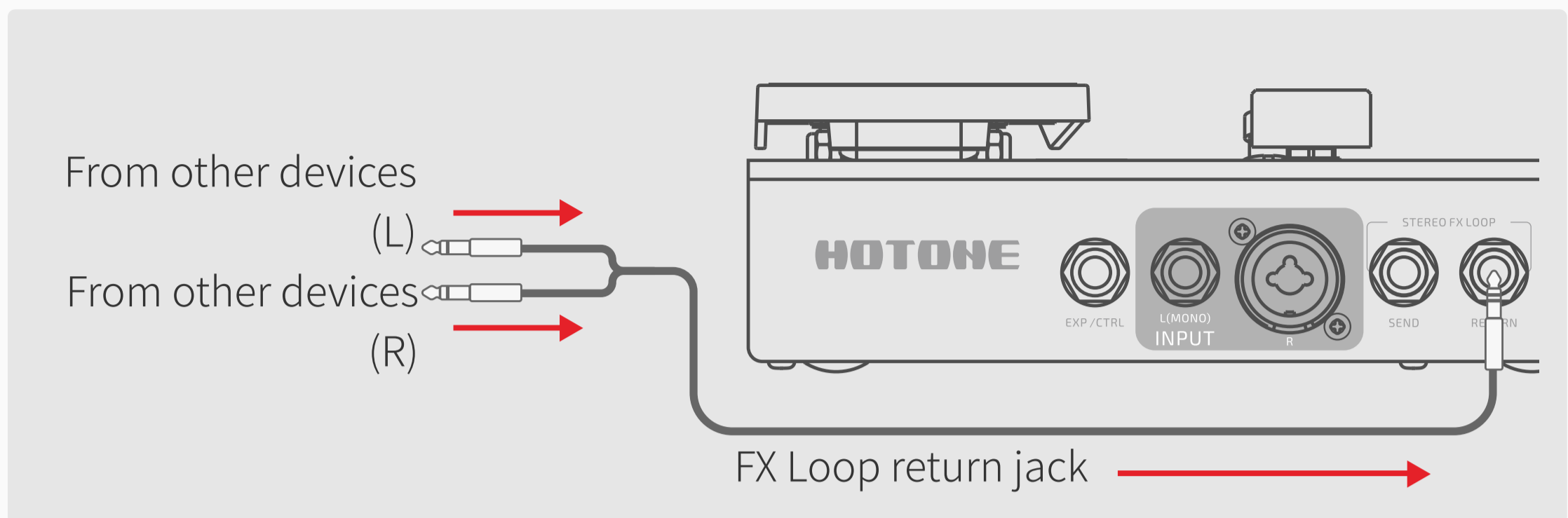

- 5. UNBALANCED OUTPUT:** 1/4" (6.35mm) unbalanced stereo output connections to amplifiers or other equipment. For mono output, use only the left unbalanced output.
- 6. BALANCED OUTPUT:** A pair of balanced XLR outputs for stereo connection to mixer or audio interface. For mono output, use only the left balanced output. XLR's ground connection can be cut off in the GLOBAL settings.
- 7. AUX IN:** 1/8" (3.5mm) stereo input for connecting external devices (phone, MP3 player) for practice and jamming (or recording)..
- 8. PHONES:** 1/8" (3.5mm) stereo output for connecting headphones.
- 9. USB:** USB 2.0 Type-C connects to your computer.
- 10. Power Switch:** Turns power on/off.
- 11. Power Supply Connection:** Power supply input (9-18V DC center negative). We strongly recommend **always use the included genuine power adapter.**
- 12. MIDI OUT/THRU:** Standard 5-pin MIDI OUT for sending/transferring MIDI messages.
- 13. MIDI IN:** Standard 5-pin MIDI IN for receiving MIDI messages or connecting a MIDI controller.

» Getting Started

1. Connecting your unit

Plug your guitar in to the Ampero II's input L jack and run a cable from OUTPUT L to your amp. Please remember:

- Keep your amp volume down.
- Connect your cable to the amp's FX Loop Return if it has one (see **Suggested Setups** section)
- When using with studio monitors, we suggest to use a stereo pair of monitors for best possible experience. Remember to turn monitor power off or turn monitor volume down before connection to prevent from possible device damage/hearing loss.
- When using with headphones, we suggest to use studio monitor headphones for best possible experience. Headphones with built-in microphone are not recommended – the TRRS connector may not be correctly recognized due to different manufacturers, which may lead to malfunction.

2. Connect the power supply and turn ON.

3. Tune your guitar. Press and hold footswitch 3 until the TUNER comes on the display screen. (see **Tuner** section).

Pluck each string and tune until the pitch reaches the middle of the screen and turns green, as below:

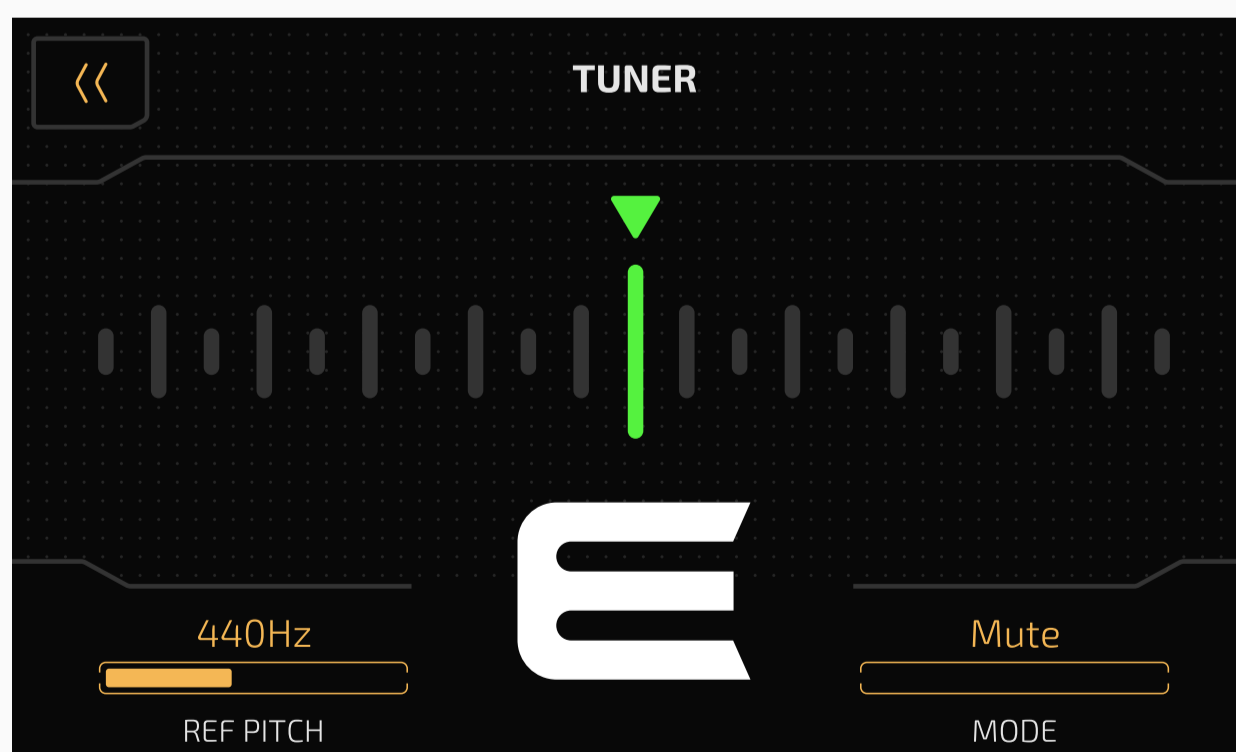

When finished, tap any footswitch to exit the tuner.

4. Select a patch:

- Tap footswitch 1-4 to choose a patch you like.
- Tap footswitches 1 and 2 (or 2 and 3) together to move backward or forward through the banks, tap footswitch 1-4 to select a patch.

» Using the Interface

Touch operation

Changing patches and editing settings can all be done with the touchscreen:

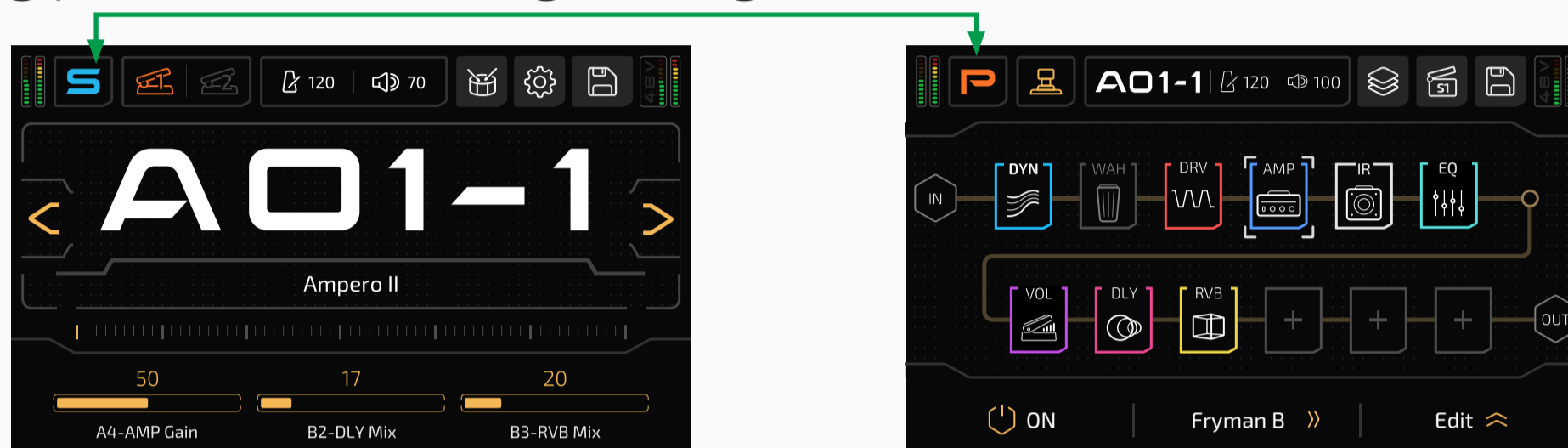

Sliding on one bar in parameter list to adjust:

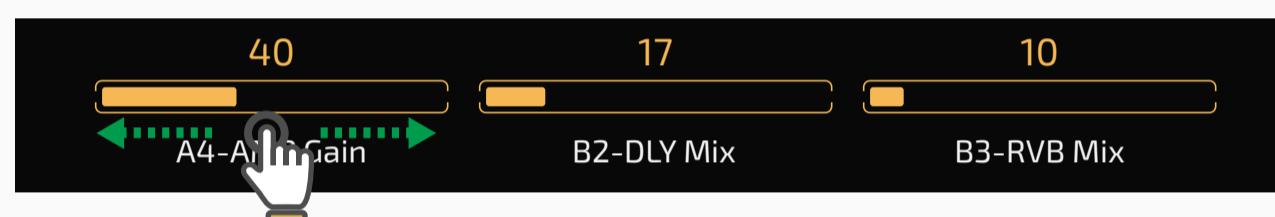

Tap on left/right side of the bar for fine tuning a parameter:



Tap=Value-1 Tap=Value+1

< > buttons indicate there are more parameters to be shown. Press to go to previous/next page to check them out:

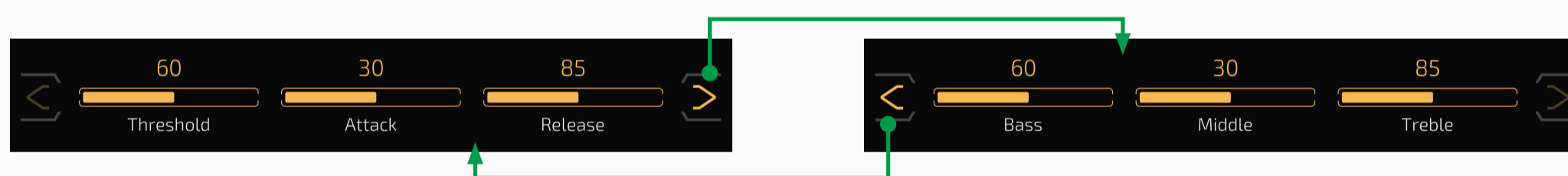

Main Knob

Turning the main knob lets you select the object you want to control:



The white square indicates current cursor location

Then press the knob to confirm the selection:



*The highlighted patch number square indicates current selection
Then turn Main Knob to go through the patches*

- If the selected object is a button, it will respond as if you'd touched the button on the touchscreen.
- If the selected object is a parameter, you can use the main knob to adjust the parameter value. Pressing the main knob again will take you back to selection mode.
- When you touch a parameter, it will be selected, and you can then adjust its value by turning the main knob.

Reminder: The details of use and programming may slightly vary under certain operational circumstances. Please read this manual carefully to get all the necessary information.

» Unit Mode and Main Display

Ampero II features two modes: Patch Mode and Stomp Mode. Default is set to Patch Mode.

Patch Mode is a “classic” mode friendly for most multi-effects users, which is recommended to users who are new to Ampero II or who prefer classic operations.

In this mode:

- Use footswitch 1-4 to select between patch 1-4 in the current bank
- One of the footswitch LEDs will be steady to indicate selected patch
- In default, press footswitch 1 and 2 together to go to the previous bank, press footswitch 2 and 3 together to go to the next bank, use footswitch 1-4 to select a patch; change bank selection methods in **Global settings**.

Stomp Mode is recommended to users who prefer pedalboard-like operations. Press and hold footswitch 4 to switch between Patch Mode and Stomp Mode.

In this mode:

- You can edit effect chain, modules, effects or use the footswitches to toggle effects on/off, select a scene, tap tempo, etc.
- The screen display features two views: FX Chain View for showing effects chain routing. Footswitch View for footswitch functions
- Edit effect chain, modules, effects in FX Chain View
- Edit footswitch functions in Footswitch View
- Footswitch function and LED color depend on your footswitch settings

When you press the screen lock button, the screen lock menu will differ depending on the mode you’re using:

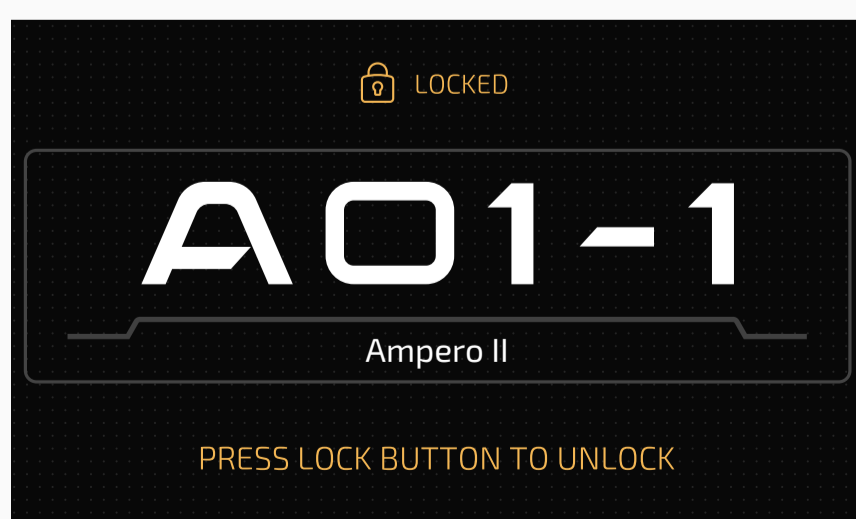

Patch Mode

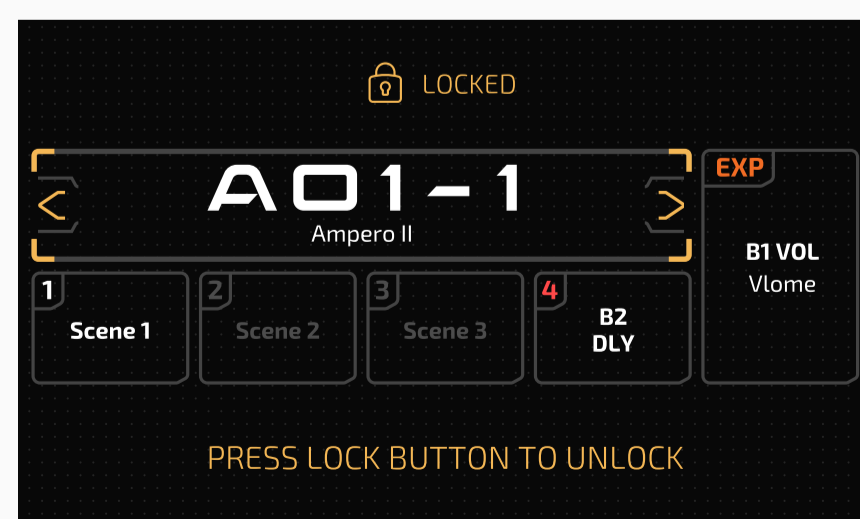

Stomp Mode

Patch Mode

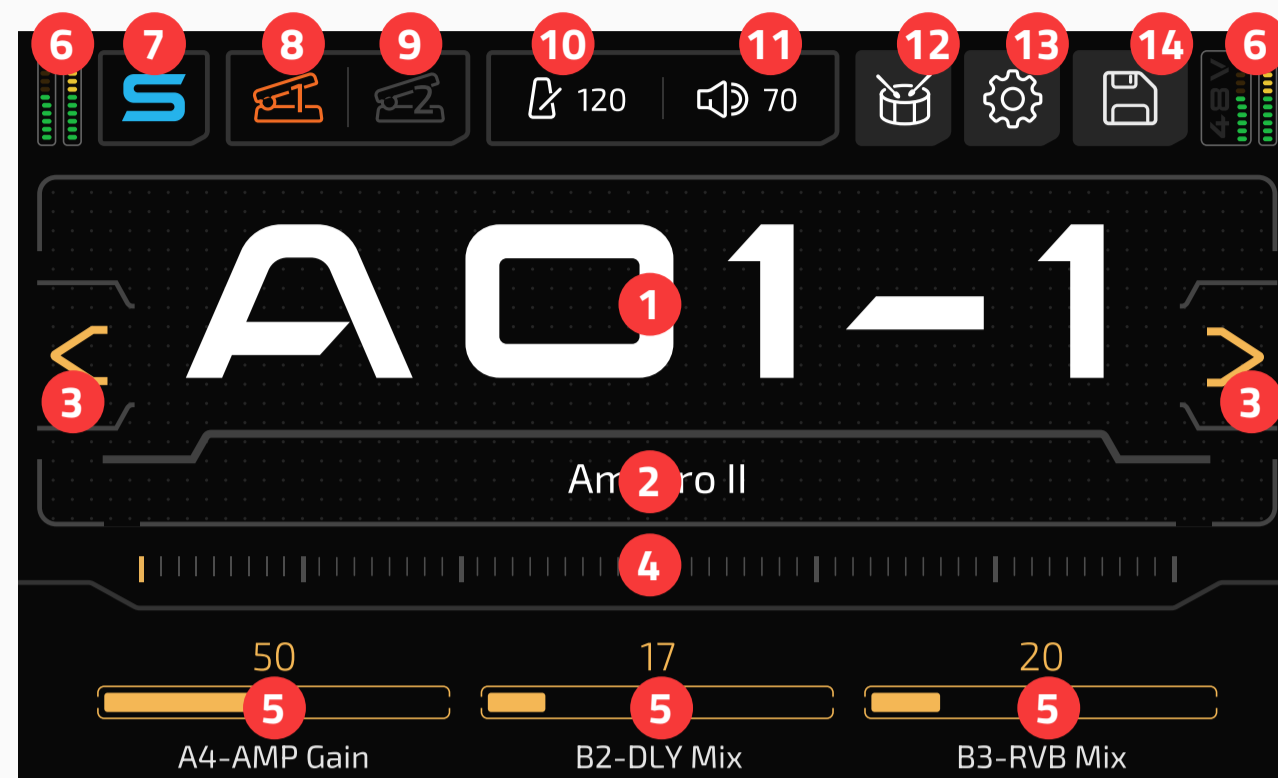

1. Current patch number; press to enter patch list (see **Patch Management** section)
2. Current patch name; patch number and name may swap depending on your settings (see **Display** section)
3. Patch selection forward/back button
4. Slide on the bar to go through the patches
5. Parameter list: In Patch Mode, this indicates quick access parameters of current patch; hold the parameter name to change the parameter you're controlling (see **Patch Settings** section)
6. Leveling meter that indicates current I/O level:

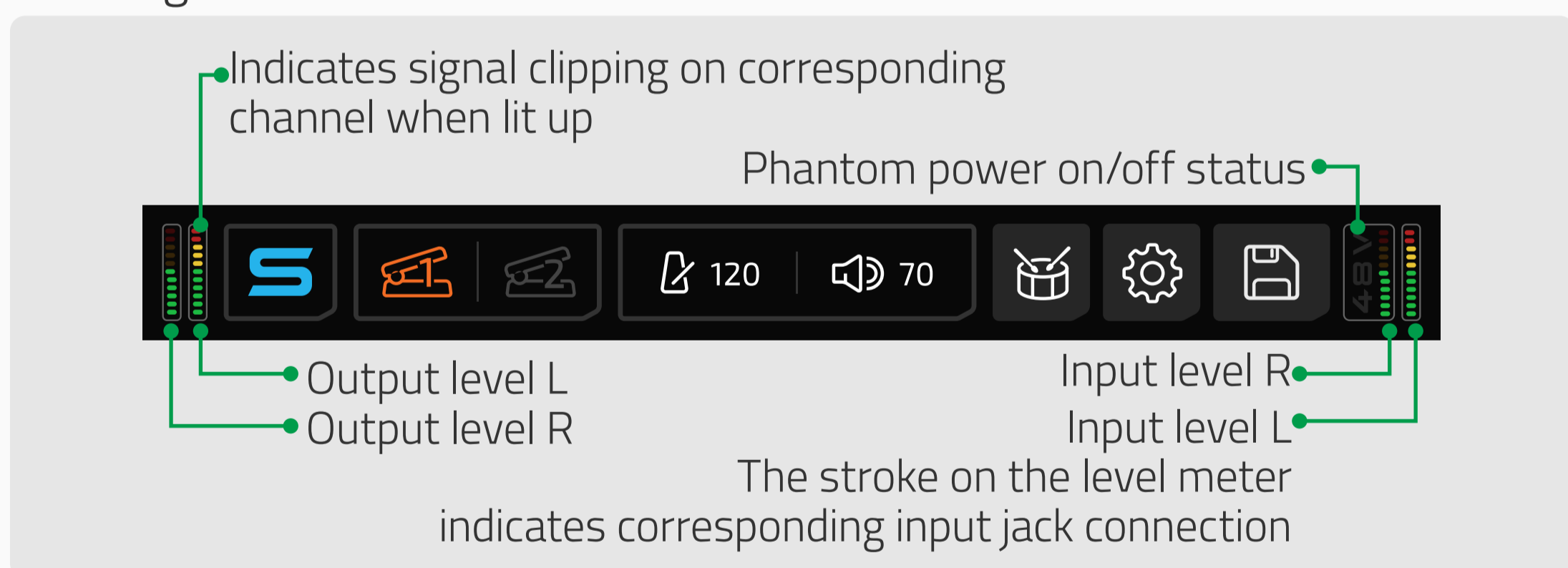

7. Tap to enter Stomp Mode
8. Tap to engage expression pedal 1; hold for expression pedal 1 settings (see **Patch Settings** section)
9. Tap to engage expression pedal 2; hold for expression pedal 2 settings (see **Patch Settings** section)
10. Indicates the current patch tempo; press to enter patch tempo:

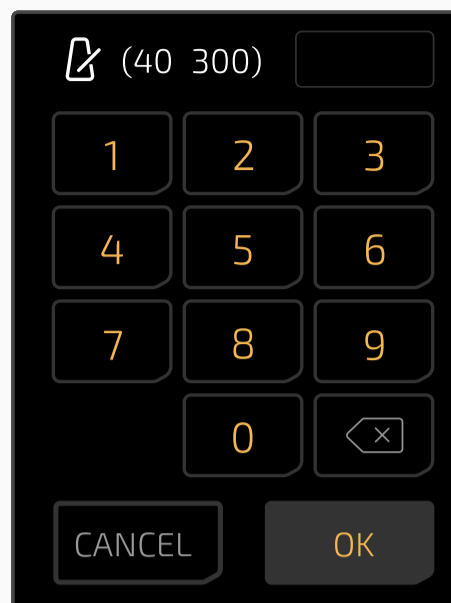

11. Indicates current patch volume; press to adjust:

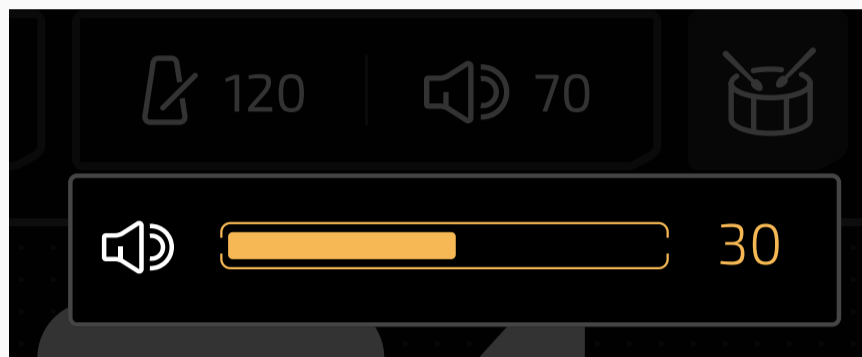

12. Tap to enter Drum menu (see **Drum** section)

13. Tap to enter global settings menu (see **Global** section)

14. Tap to save current patch settings (see **Save** section)

Stomp Mode (FX Chain View)

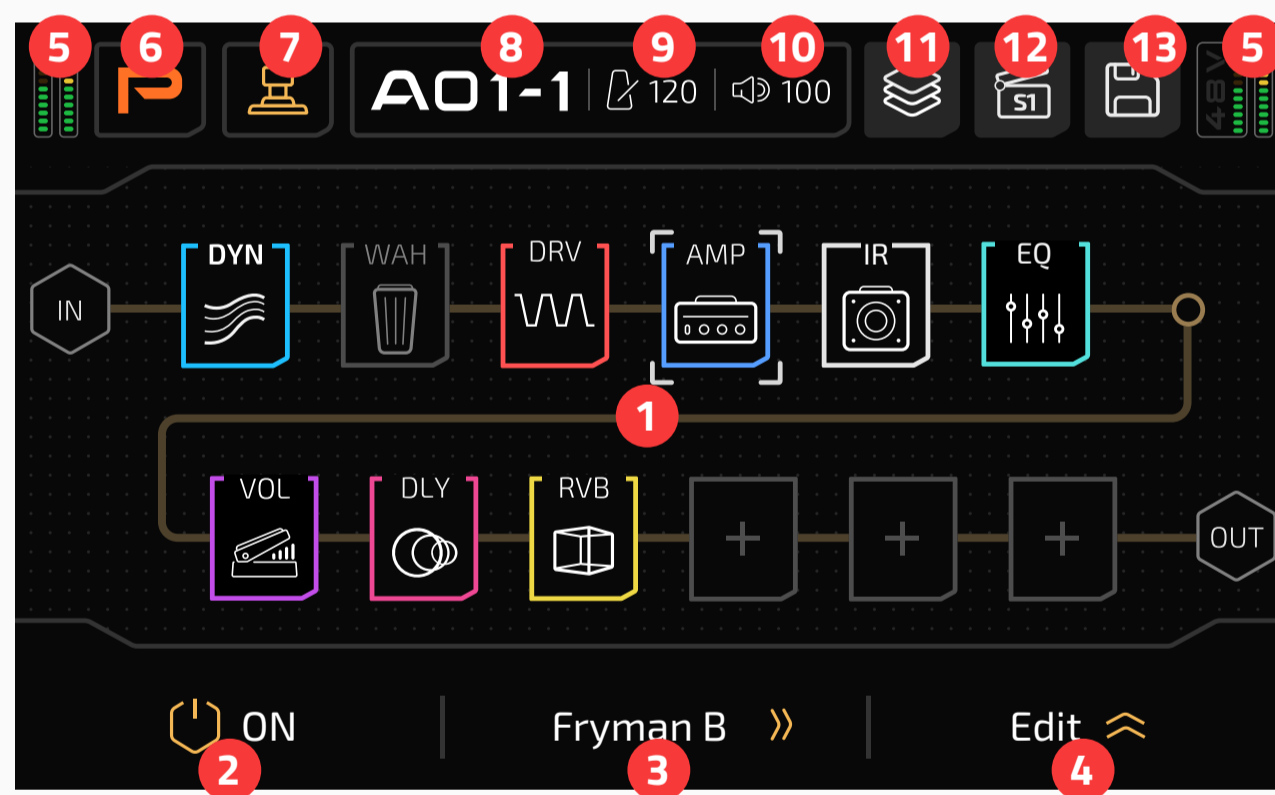

1. FX chain settings in current patch
2. Turn selected slot on/off
3. Press to enter effects list and change effect
4. Press to expand available parameters of current effect
5. I/O meter (same as Patch Mode)
6. Tap to enter Patch Mode
7. Tap to enter Footswitch View
8. Current patch number; tap to enter patch list

9. Patch tempo (same as Patch Mode)
10. Patch volume (same as Patch Mode)
11. FX chain template menu
12. Scenes menu (see **Scenes** section)
13. Save menu for saving patches and effects chain templates

Stomp Mode (Footswitch View)

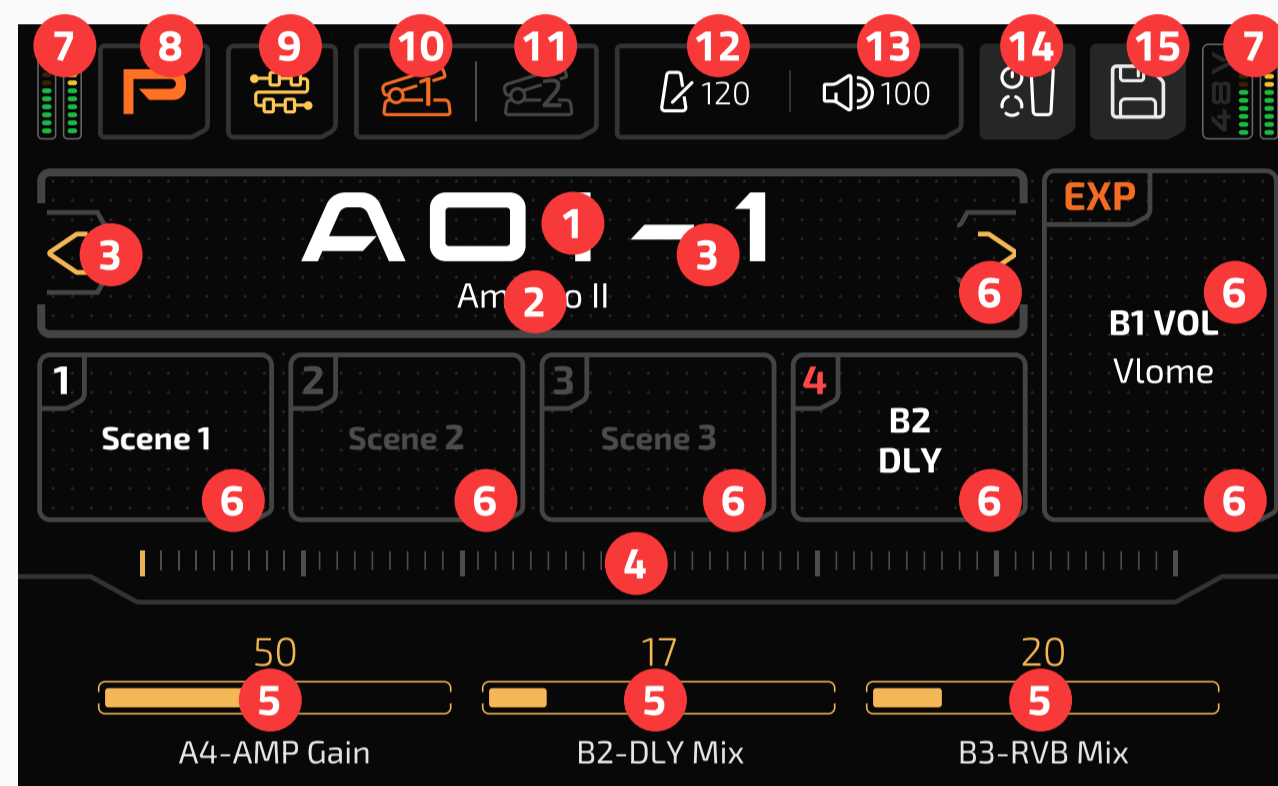

1. Current patch number; press to enter patch list (same as Patch Mode)
2. Current patch name (same as Patch Mode)
3. Patch selection forward/back button (same as Patch Mode)
4. Slide on the bar to go through the patches (same as Patch Mode)
5. Parameter list (same as Patch Mode)
6. Indicates the function of the footswitches/EXP in the current patch; hold to assign a function (see **Patch Settings** section)
7. I/O meter (same as Patch Mode)
8. Tap to enter Patch Mode
9. Tap to enter FX Chain View
10. EXP pedal 1 status (same as Patch Mode)
11. EXP pedal 2 status (same as Patch Mode)
12. Patch tempo (same as Patch Mode)
13. Patch volume (same as Patch Mode)
14. Tap to enter Patch Settings menu
15. Save menu (same as Patch Mode)

» Tuner

Hold footswitch 3 to open the tuner.

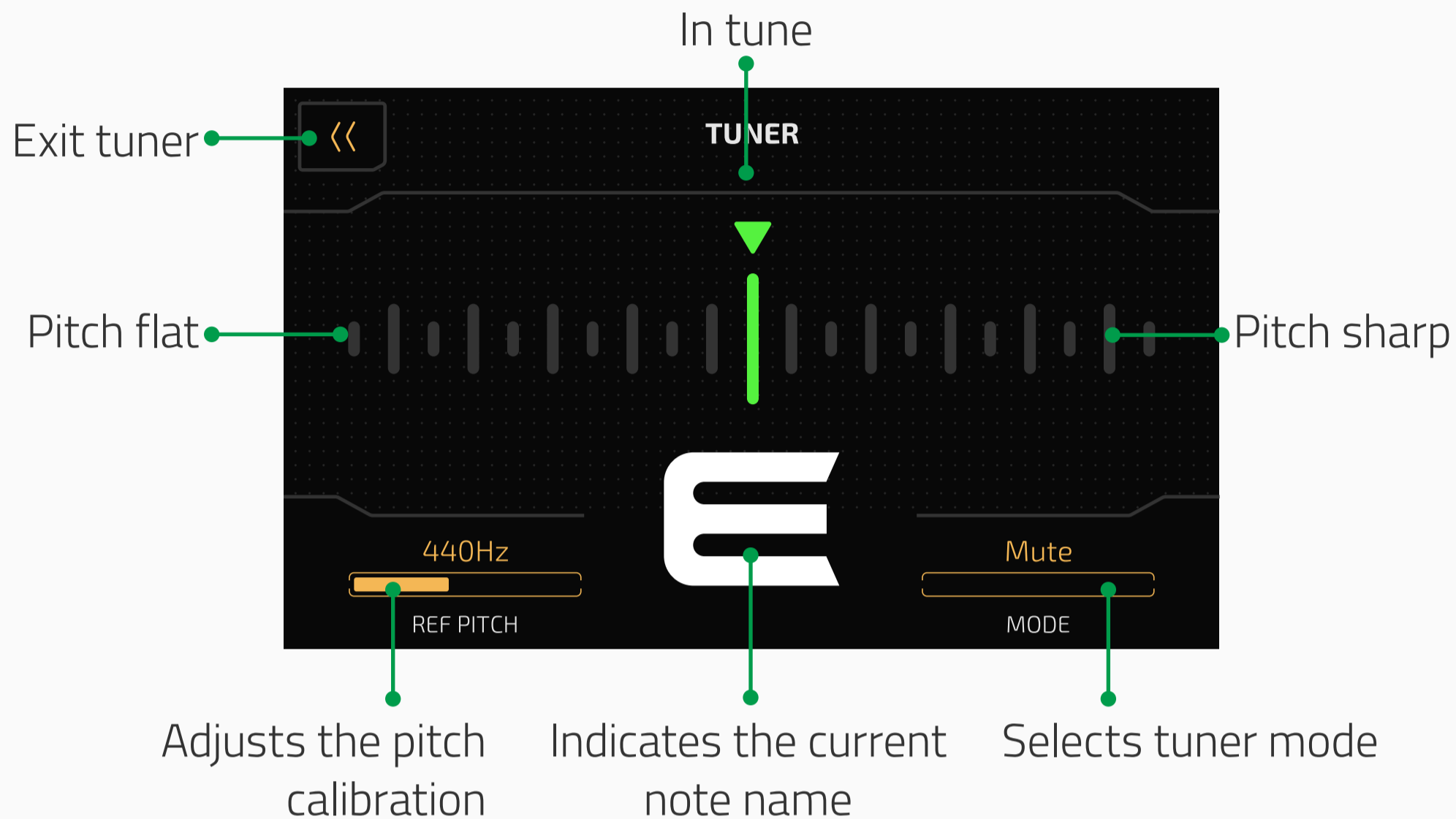

On the upper part is a scale that indicates your pitch. Left of center is flat, and right of center is sharp. As you tune your instrument towards the middle, the color of the scale will change from red (out of tune) to yellow (near pitch) to green (in tune).

REF PITCH lets you adjust the pitch calibration ranging from 415Hz to 475Hz. Standard pitch is set at 440Hz.

MODE lets you select the tuner mode, either Thru (for effect signal through), Bypass (for dry signal thru) and Mute (for silent tuning).

You can exit the tuner either by pressing any footswitch or by pressing the Back button on the touchscreen.

»» Looper

Press footswitch 3 and 4 together to open the looper menu:

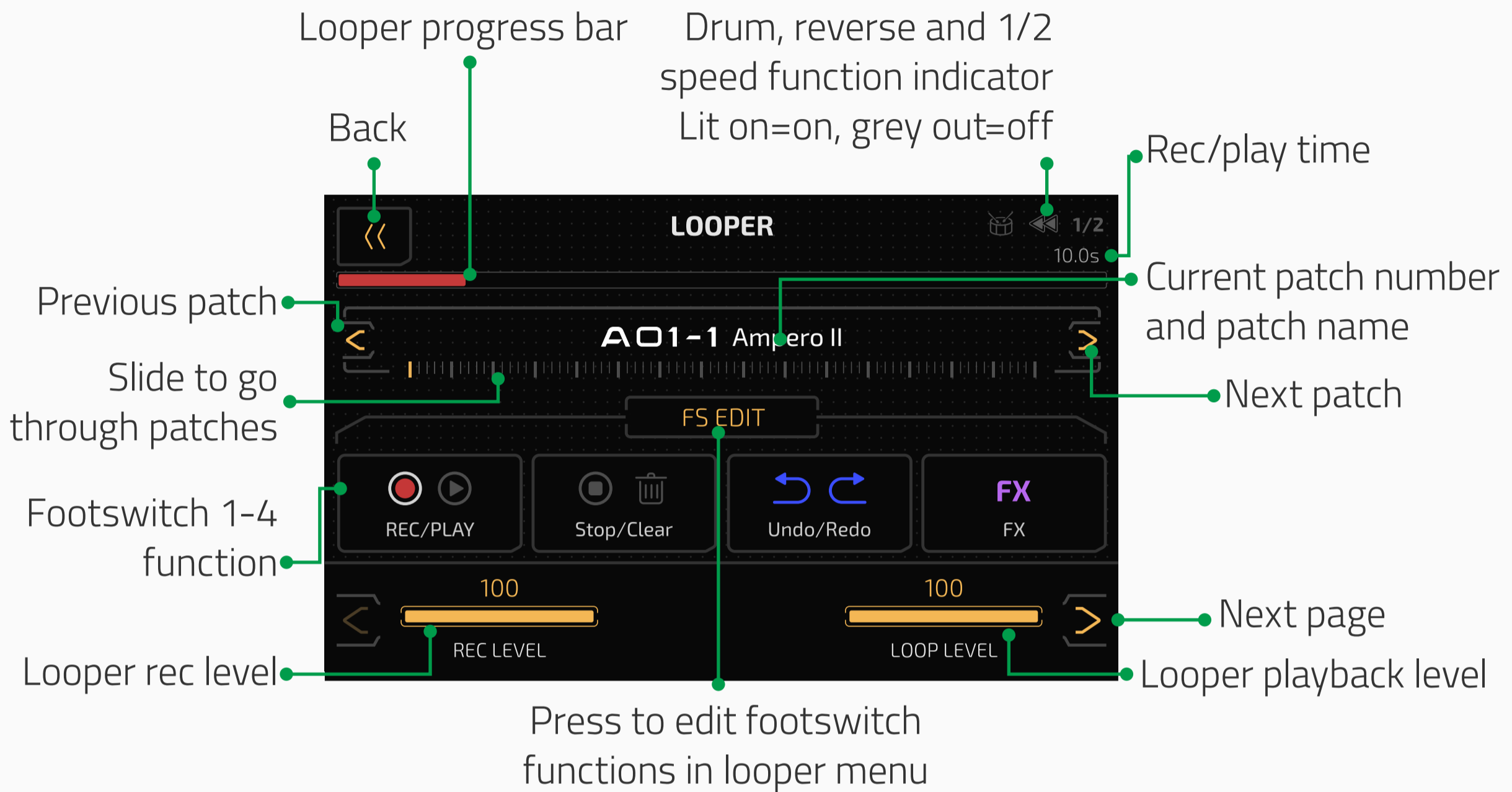

The progress bar at the top will be shown in red during recording and overdubbing. It will be shown in green during playing.

REC LEVEL adjusts the loop recording level from 0-100.

LOOP LEVEL adjusts the loop playback level from 0-100.

In default settings, use footswitch 1 to record/play/overdub, footswitch 2 to stop/clear all recorded data, footswitch 3 to undo/redo, footswitch 4 to start/stop half speed or reverse function.

Go to page 2 for further settings:



PRE/POST selects between setting the loop before (Pre) or after (Post) your effects chains. The maximum recording time is 60 seconds in both modes.

- In Pre mode, the looper will record stereo audio without any effects
- In Post mode, the looper will record stereo audio with effects

CHAIN selects between setting the loop in chain A or chain B.

Press FS EDIT button to enter Looper FS Settings menu:

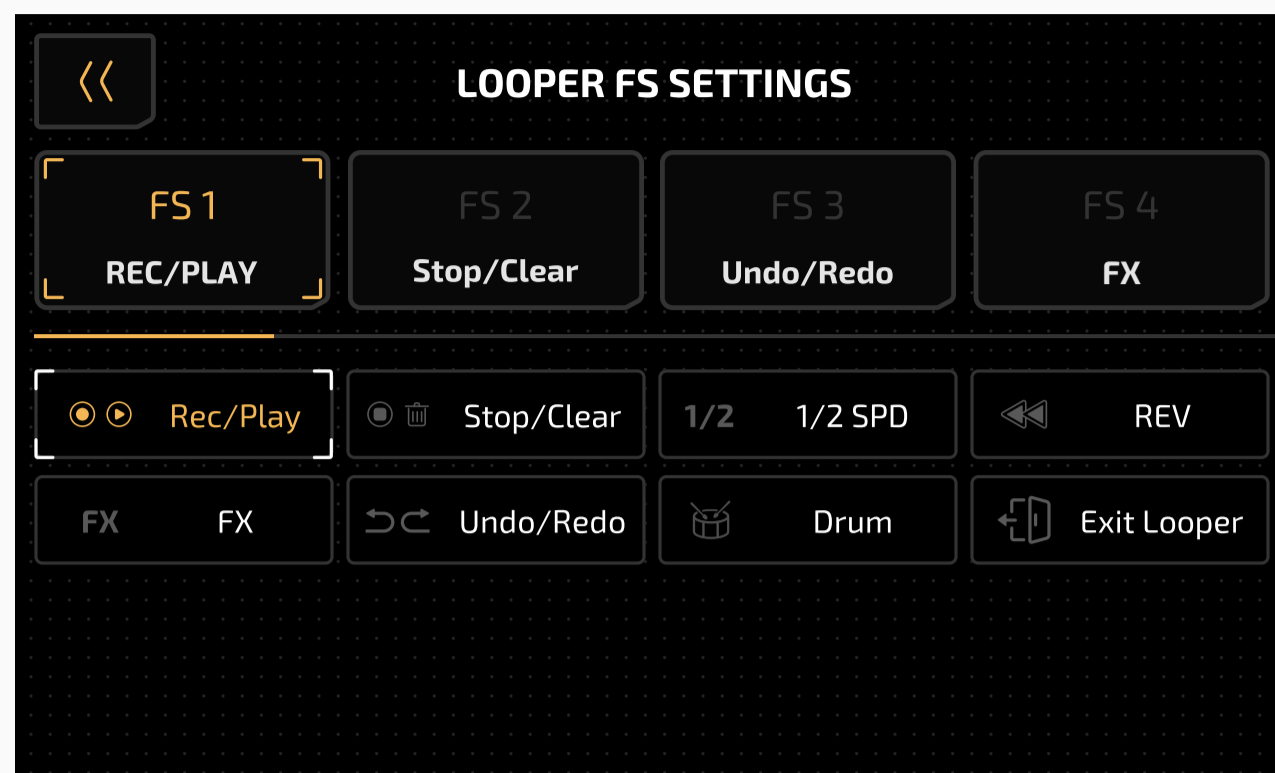

- Rec/Play: Tap to recording, then tap again to start playback
- Stop/Clear: Tap to stop recording and hold to clear
- FX: Tap to toggle 1/2 speed function, hold to toggle reverse function (violet LED steady)
- 1/2 SPD: On (yellow LED on)/Off (yellow LED off)
- REV: On (white LED on)/Off (white LED off)
- Undo/Redo: Tap to undo/redo last overdub phrases (blue LED steady)
- Drum: Start/stop drum playback
- Exit Looper: Exit looper page (cyan LED steady)

You can use drum function while looping. When you record phrases with drum rhythms, the drum rhythm will automatically sync to your loop phrase. In this case, we recommend to turn on drum first before recording a loop phrase. Some unusual operations (e.g. randomly play/stop looping or drum machine, change drum style/tempo during looping, randomly engaging/disengaging 1/2 SPD or REV) will break the sync status.

Exit the looper by pressing back button on the upper left of the screen. The current looping status won't be affected.

Looping operation and status modes:

Operation	Function/ Status	LED Color (Rec/ Play)	LED Color (Stop/ Clear)
On with no data	Stop	None	None
Tap Stop/Clear footswitch while loop is playing	Stop	Flashing green	Flashing green
Tap Rec/Play footswitch when there's no data	Record	Steady red	None
Tap Rec/Play footswitch while recording, overdubbing, or paused	Play	Steady green	Steady green
Tap Rec/Play footswitch while loop is playing	Overdub	Steady blue	Steady blue
Hold Stop/Clear footswitch	Clear	Quickly flashing green	Quickly flashing green
Each time a recorded loop plays from the beginning	Play	Single flash	Single flash
Tap Undo/redo footswitch during playback	Undo/redo	Single flash	Single flash

Reminder:

1. When the loop recording reaches it's time limit, the looper will automatically stop the recording and begin playback.
2. When the looper is in Post mode, changing patches will not change already recorded loop phrases.
3. Half-speed and Reverse functions will affect all recorded loop phrases.
4. If you switch looper between pre/post while it's running, the loop will automatically stop and be erased; switching A/B will stop recording and start playback (other statuses and looping data won't be affected), the output may differ depending on effects chain and pre/post settings.

» Drum

In Patch Mode, press  button to enter drum menu:

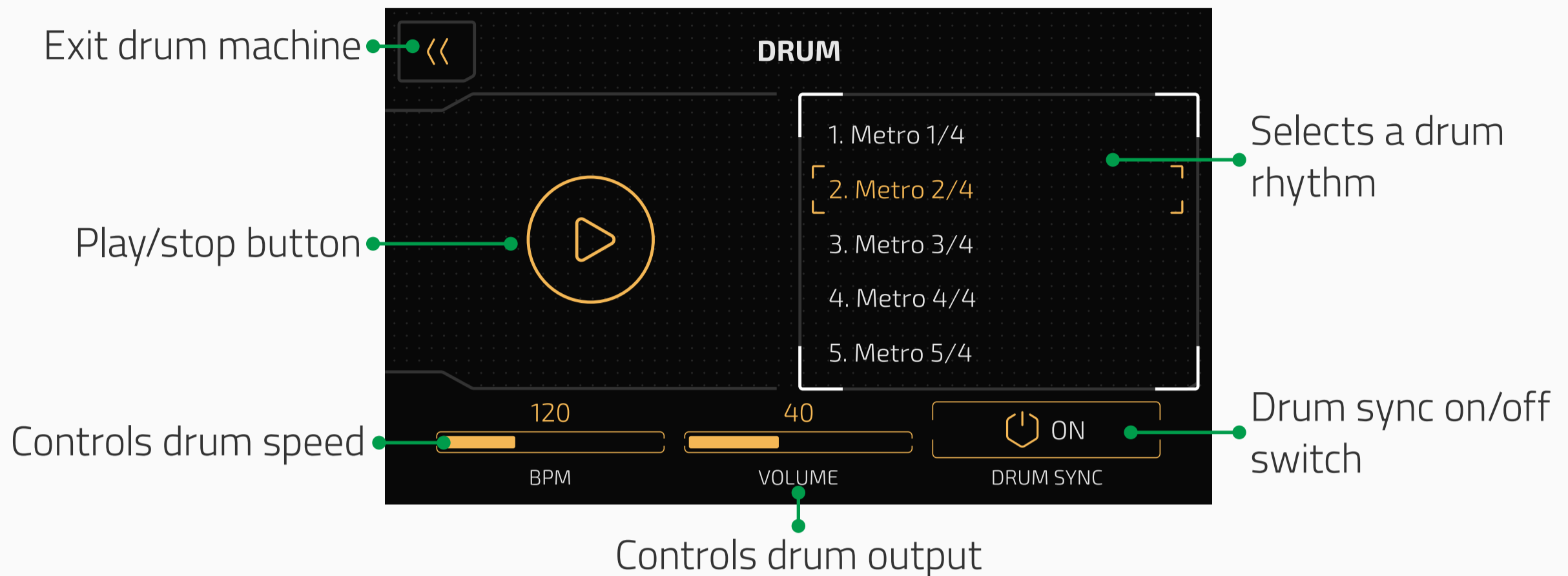

Use the style list to scroll between genre styles (see Ampero II Drum Rhythm List).

Use TEMPO to adjust the drum tempo, ranging from 40BPM-300BPM.

Use VOLUME to adjust the drum volume from 0-100.

Turn on DRUM SYNC switch if you need to set drum tempo by Tap Tempo function. In this case, the drum tempo will be synced to patch tempo.

Exit the drum menu by pressing back button at the top left. Exiting the menu will not stop the drums from playing.

Reminder:

1. Setting the drum tempo will affect patch tempo if you turn DRUM SYNC ON.
2. When using with looper, we recommend to turn on drum first before recording a loop phrase. Unusual operations may break the sync status (see **Looper** section).

» Bypass

In Patch and Stomp modes, all footswitches can be set to bypass function:

DSP Bypassing
Press any footswitch to engage

When the unit is bypassed, press any footswitch to go back to normal. Ampero II supports two bypass modes: DSP Bypass and Analog Bypass. You can set unit bypass mode depending on your needs (see **GLOBAL** section).

Please note:

1. Bypassing the unit will also bypass USB Audio.
2. Ampero II features a hardware true bypass in Analog Bypass mode, which supports mono in/out, stereo in/out configuration only (mono in/stereo out not supported).
3. In Analog Bypass mode, the phones output will be MUTED when bypassed.
4. In Analog Bypass mode, XLR input of Input R and outputs are disabled.

» Customizing Your Unit

This section will show you how to customize your Ampero II's settings, edit patches, using scenes, setup the expression pedal, and change other features to your taste.

Edit A Patch

Edit your patches to get the tone you want.

Remember that turning the effect slots on/off and adjusting parameters will change the current patch. If you switch patches or turn the unit off before saving your changes, the changes will be lost.

Make sure to press **SAVE** on the upper right of the display screen to save your settings.

You can start with any patch you like or choose an empty patch (A32-1 to A75-4 in default).

Effects Chain Basics

In Stomp mode, switch to FX Chain View to check out current effects chain:

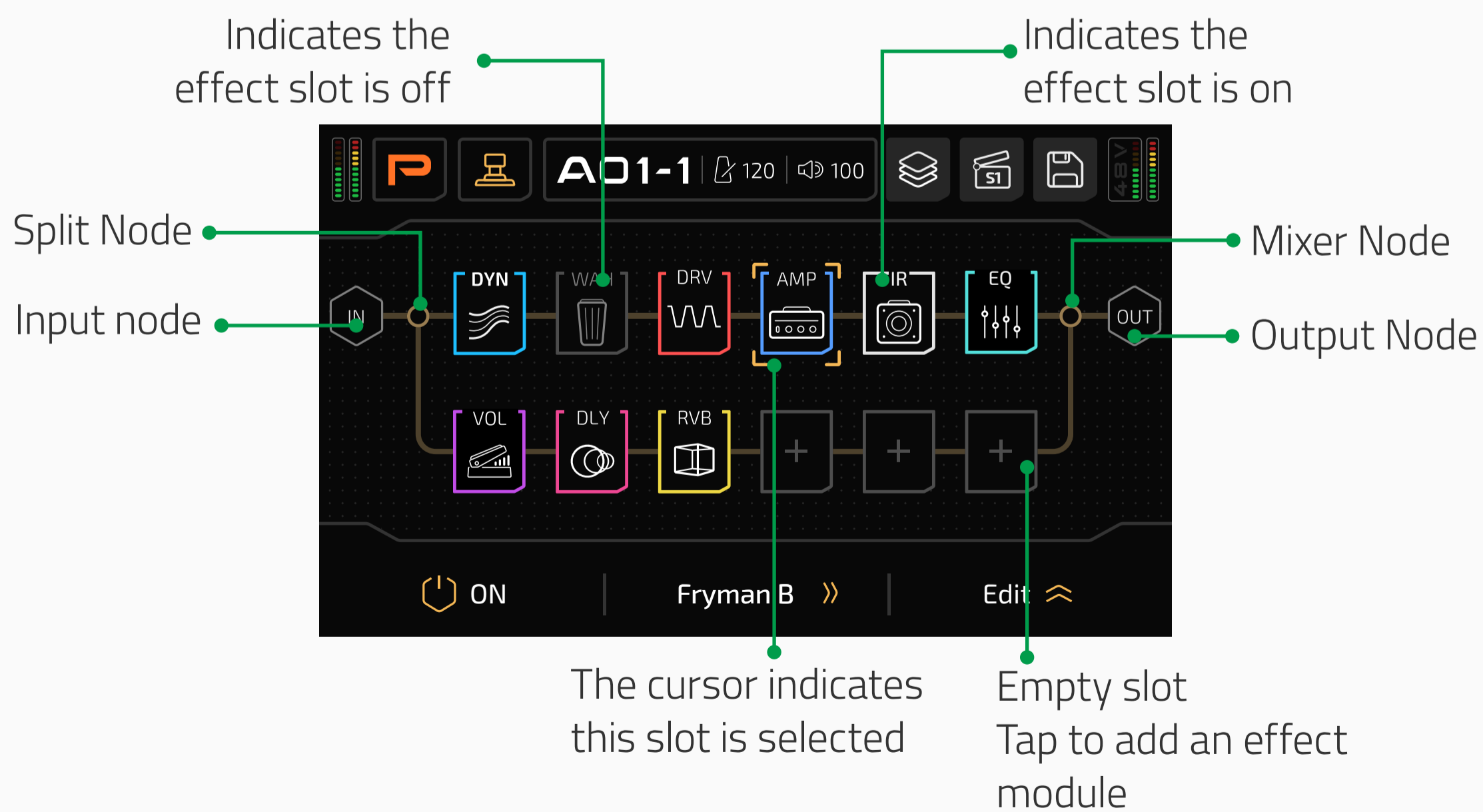

This shows how your Ampero II processes your sound by showing internal signal flow, effect combination, etc.

Now let's see detailed effects chain info:

Effects Chain

The upper effects chain is called effects chain A (or simply "chain A"), the lower chain is called effects chain B (or simply "chain B"):

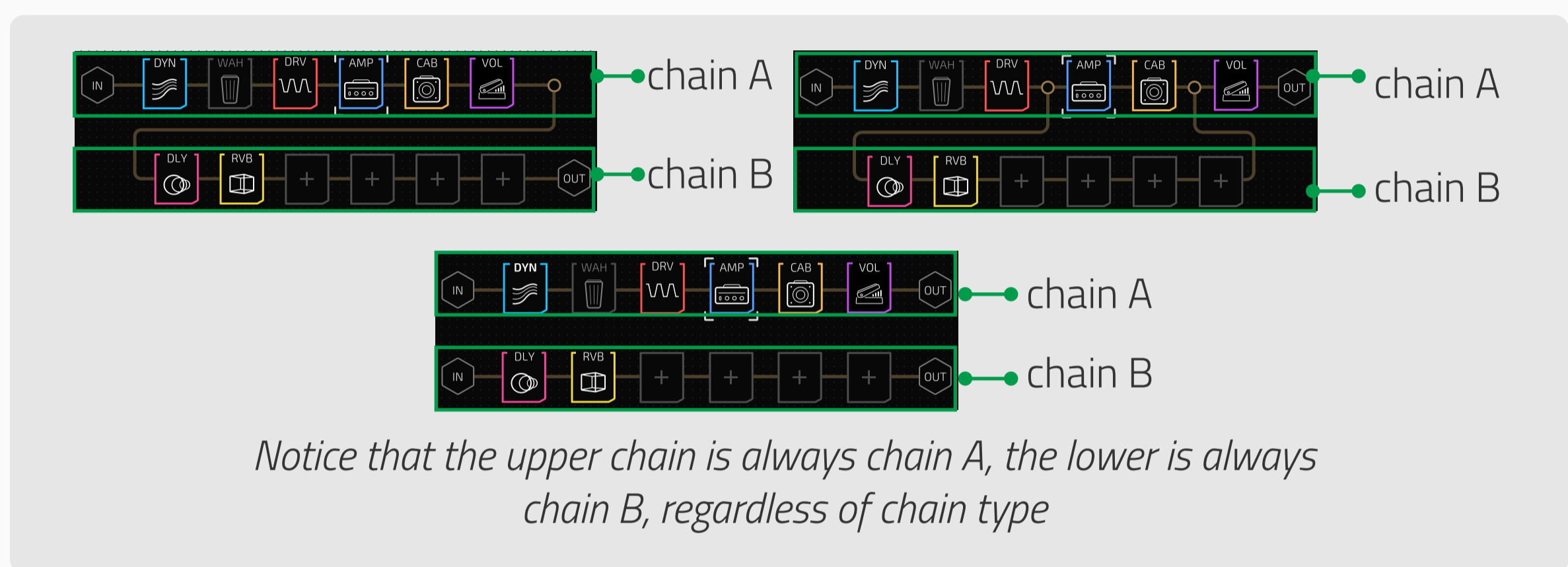

The signal flow direction is fixed from left to right:

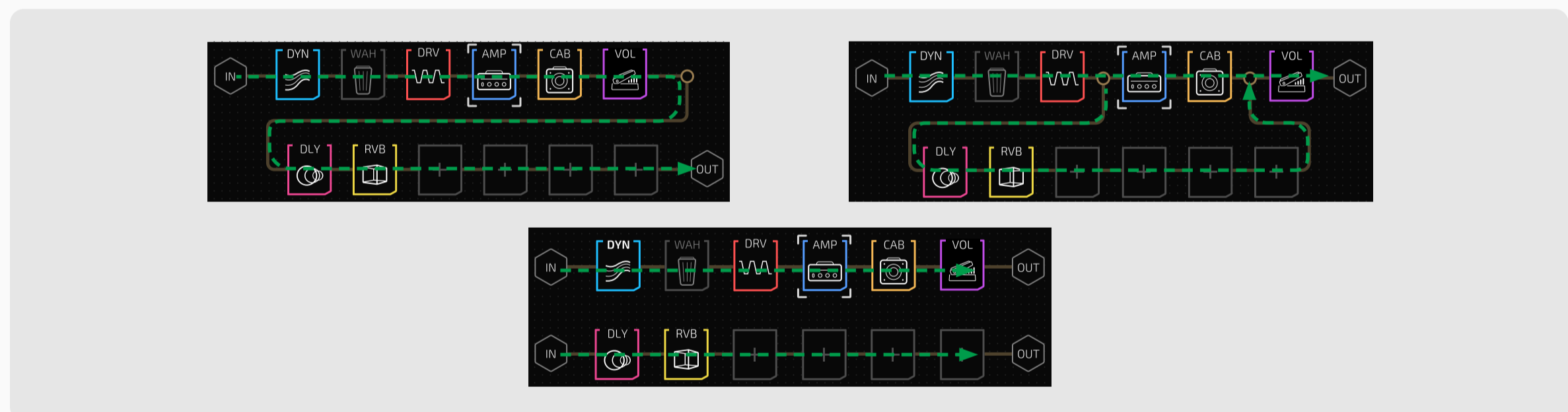

Nodes

The beginning/end of an effects chain or the intersection of two effects chains is called a "node":

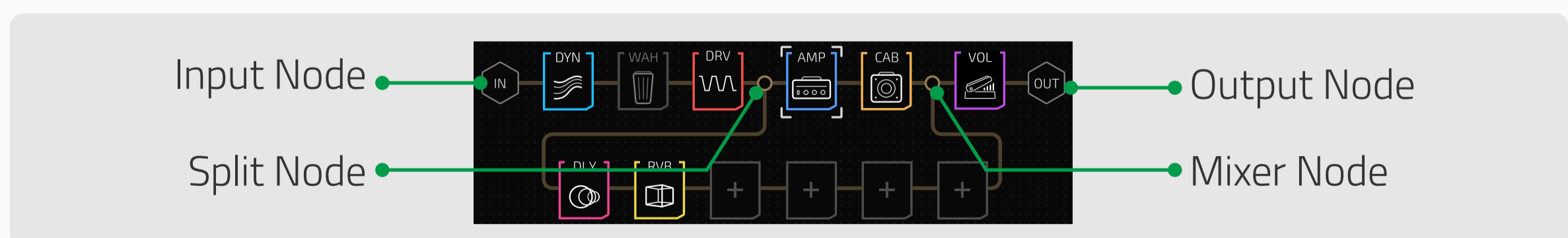

Input node is the beginning of an effects chain that sets signal input source.

Output node is the end of an effects chain that determine where the signal outputs to.

Split node separates one effects chain into two and sends separated signals in a certain way that determined by node settings, **appears on chain A only.**

Mixer node mixes two effects chains into one and outputs in a certain way that determined by node settings, **appears on chain A only.**

Effect Slots

Effect slots (or simply "slots") are spaces located on an effects chain for adding effects. Ampero II features 6 slots on one effects chain, 12 slots in total. Slot numbering is shown below:

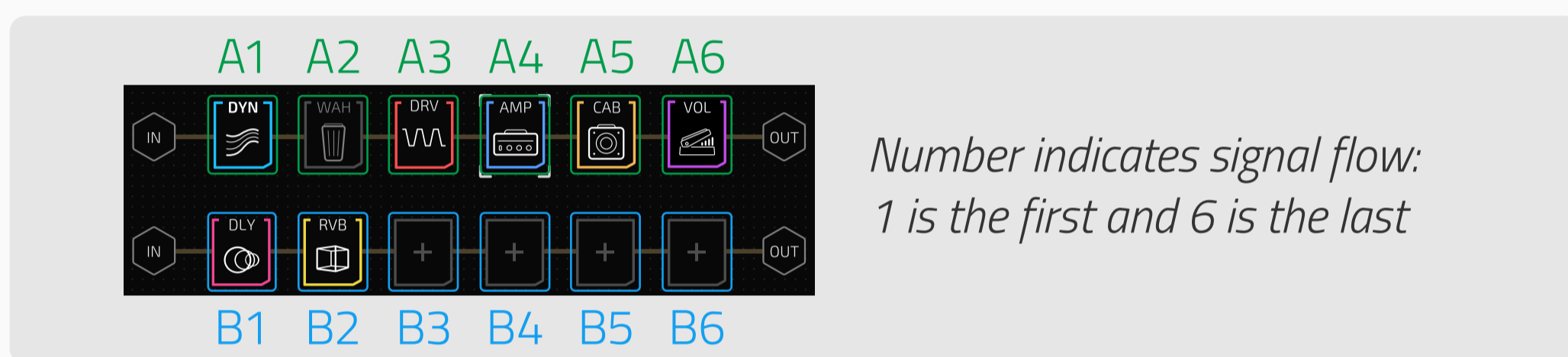

Modules

A blank effect slot is just like a short cable that have no effect on your tone. So, if you want to start your tone sculpting, you need to add an effect module (or simply "module"), and pick one effect contained in the module. Ampero II features 13 effects modules as listed below:

- DYN: Dynamic effects like compressor, boost, noise gate, etc.
- FREQ: Filter-based effects like low/band/high pass filter, envelope/auto filter, pitch shift/detune, octave, etc.
- WAH: Wah pedal
- VOL: Volume pedal
- DRV: Overdrive and distortion
- AMP: Amp modeling effects
- PRE AMP: Preamp effects incl. acoustic/bass preamps
- CAB: Cabinet simulations

- IR: For loading built-in factory IRs (incl. acoustic IRs) and user IRs
- EQ: Equalizers
- MOD: Modulation effects
- DLY: Delay effects
- RVB: Reverb effects

There are also 3 FX Loop related modules:

- FX SND: FX loop send module for sending signal to external devices via unit's FX loop send jack
- FX RTN: FX loop return module for receiving signal from external devices via unit's FX loop return jack
- FX LOOP: FX loop module for inserting external effects to an effects chain via unit's FX loop jacks

Effect Slot Status

There are three slot status shown as below:

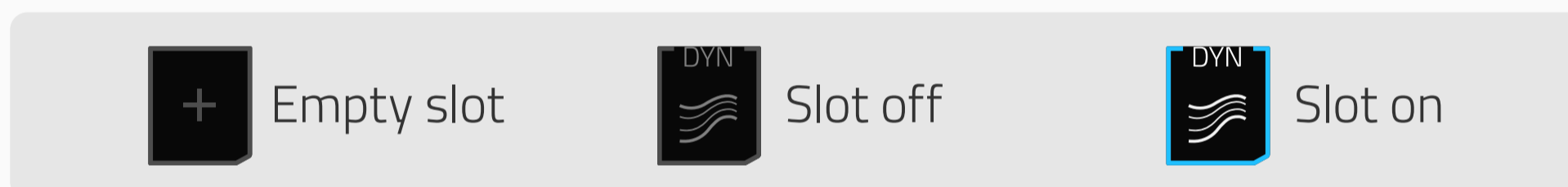

- **Empty slot** - the slot acts like a cable
- **Slot off** – the slot is bypassed, and the module in the slot doesn't work
- **Slot on** – the slot is on, the module in the slot is working

The next texts will show you how to edit an effects chain.

Input Node Setup

Select an input node and the parameters will come up as shown below:

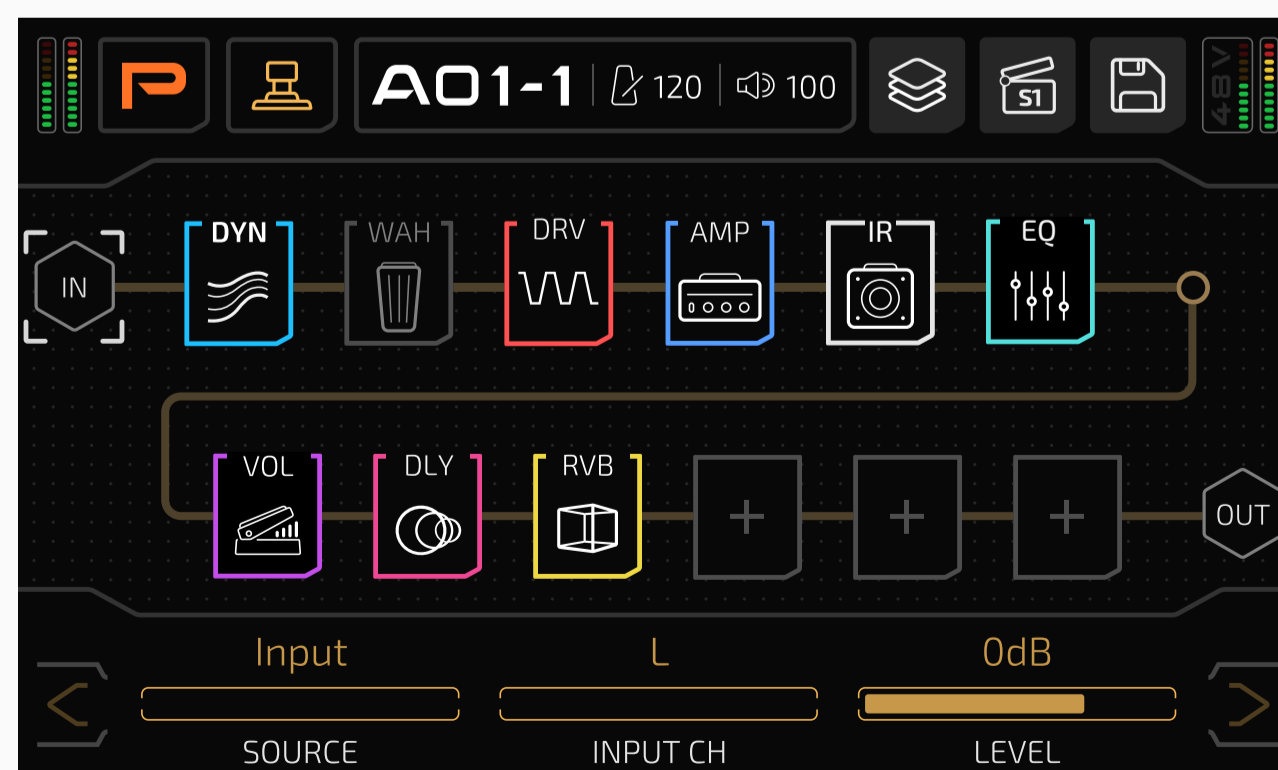

SOURCE lets you select an input signal source of current effects chain:

- Input: Sets the effects chain input source to the unit's input jack
- FX RTN: Sets the effects chain input source to unit's FX loop return jack
- USB 3/4~7/8: Set the effects chain input source to USB audio output 3/4~7/8, which is convenient for reamping (check **USB Audio** section for details)

INPUT CH lets you select the signal input channel:

- L/R: For FX loop return jack, the left channel is connected to tip conductor and the right channel is connected to ring:

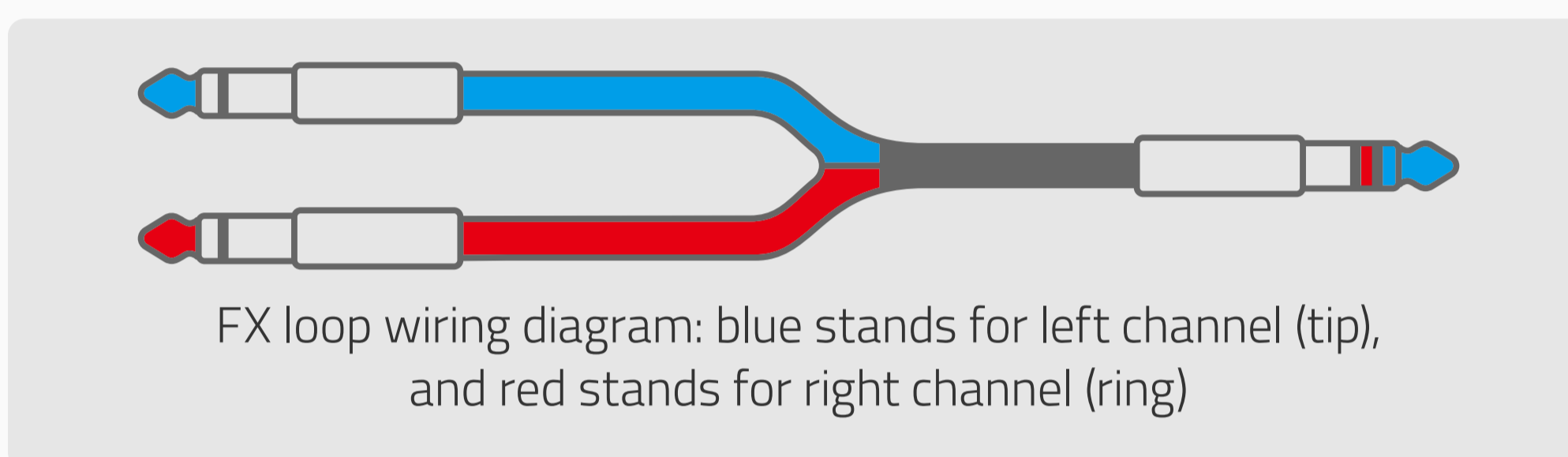

For USB outputs, even number stands for left channel (3, 5, 7) and odd number stands for right channel (4, 6, 8)

- Sum: Sums input signal to mono
- Stereo: Receives L/R stereo inputs

There are two more selections available for **chain B only**:

- None: no input, then chain B will turn gray to indicate chain B not working:



- Chain A: Receives outputs from chain A, in this case, the chain A and B connects in series (see **Effects Chain Types** section for details):



LEVEL lets you adjust input level from Mute~-60dB~+20dB. Default is set to 0dB (unity gain).

Output Node Setup

Select an output node and the parameters will come up as shown below:

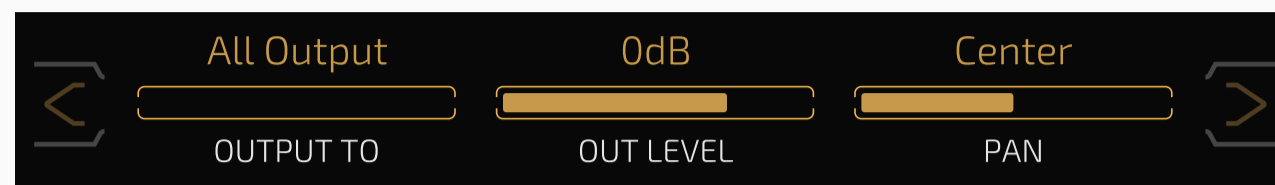

OUTPUT TO lets you decide where the output signal goes:

- All Outputs: Sets the signal output to unit's all output jacks
- Unbal.: Sets the signal output to unit's unbalanced output jacks
- Bal. & Phones: Sets the signal output to unit's both XLR jacks and phones jack
- FX SND: Sets the signal output to unit's FX loop send jack
- Chain B: For chain A only, which lets you connect chain A and B in series (see **Effects Chain Types** section for details)
- None: For chain B only, in this case, chain B's output node won't work

Special rules for chain B:

- If you set output node A's OUTPUT TO setting to All Outputs, then available selections of output node B's OUTPUT TO setting will be All Outputs, FX SND and None
- If you set output node A's OUTPUT TO setting to either Unbal. or Bal. & Phones, then available selections of output node B's OUTPUT TO setting will be Unbal., Bal & Phones, FX SND and None
- If you set output node A's OUTPUT TO setting to FX SND, then available selections of output node B's OUTPUT TO setting will be All Outputs, Unbal., Bal & Phones, FX SND and None

OUT LEVEL lets you adjust output level from Mute~-60dB~+20dB. Default is set to 0dB.

PAN lets you adjust output signal stereo panning. The range is L50~Center~R50, default is set to Center.

Note: When you set **OUTPUT TO** to **FX SND**, the VOLUME knob will not work. In this case, use **OUTPUT LEVEL** to control the output volume.

Effects Chain Types

Ampero II supports various effects chain types:

Parallel

The chain A and B are fully parallel (won't affect each other):

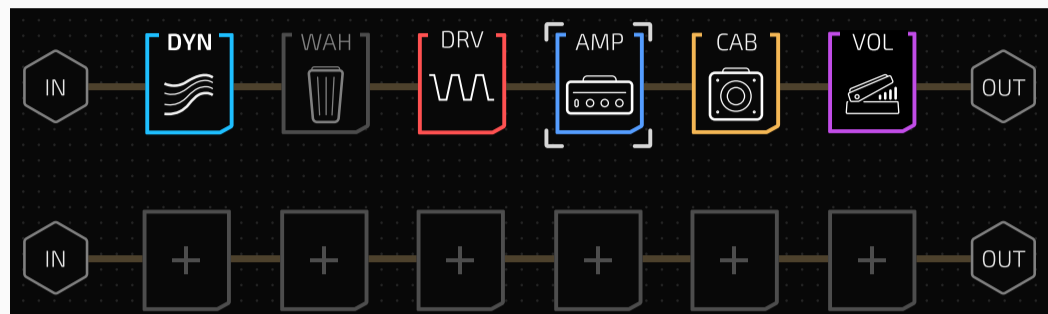

When you load an empty patch, the default effects chain type is a special parallel state that only chain A is working.

Split-Mix

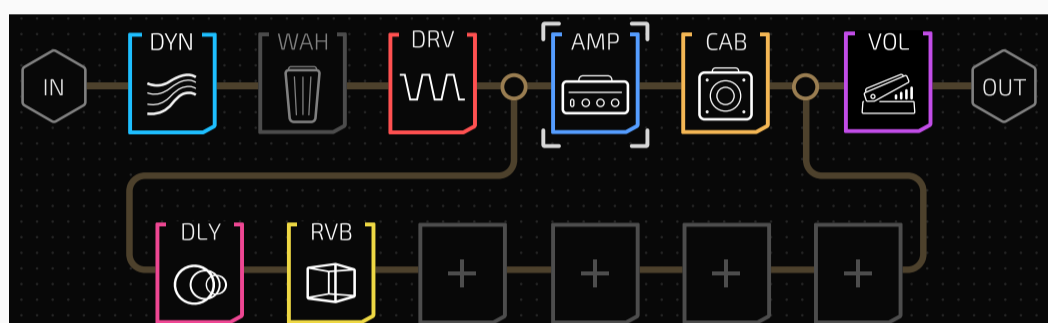

An input signal will be split into two and sent to both chain A and B, then mixed into one and sent to one output.

Y-A/B

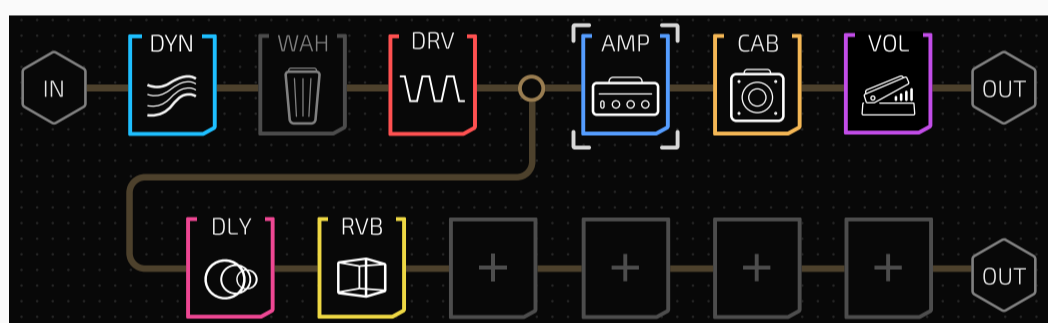

An input signal will be split into two and routed to two outputs via both chain A and B.

A/B-Y

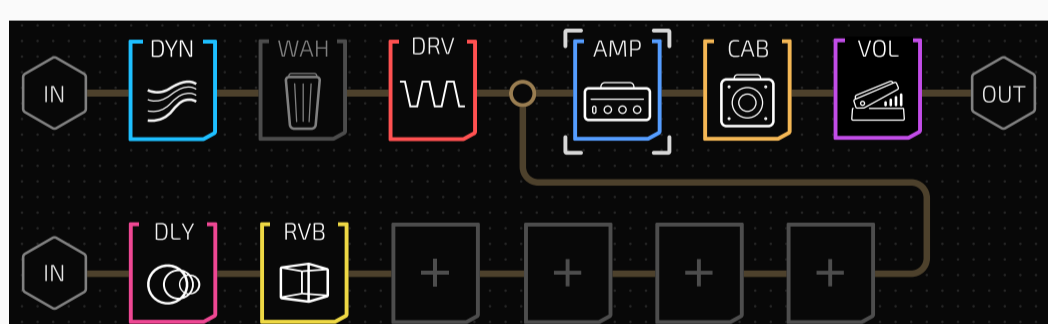

Two signal inputs will be mixed into one and sent to one output

A4-AMP Master Patch Volume

Serial

Chain A and B are connected in series (head to tail):

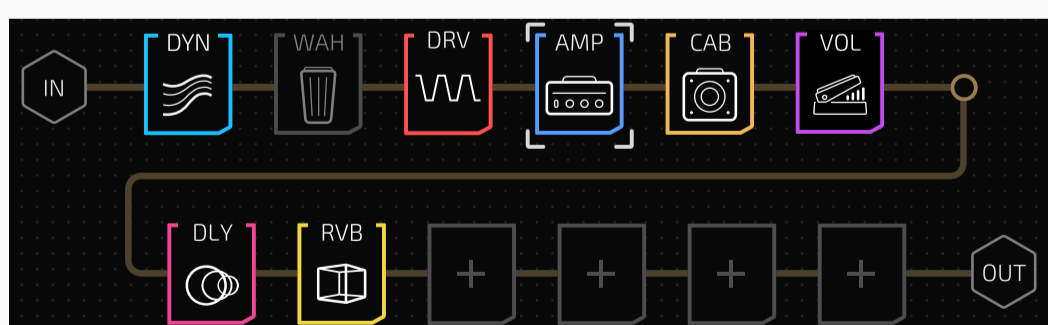

There is only one pattern when chain A and B are in series

The touch screen lets you easily change effects chain types within a few taps and drags.

Next we'll take parallel type as an example to show how to change chain types:

Change To A/B-Y

Drag and drop output node of chain B on chain A depending on your needs:

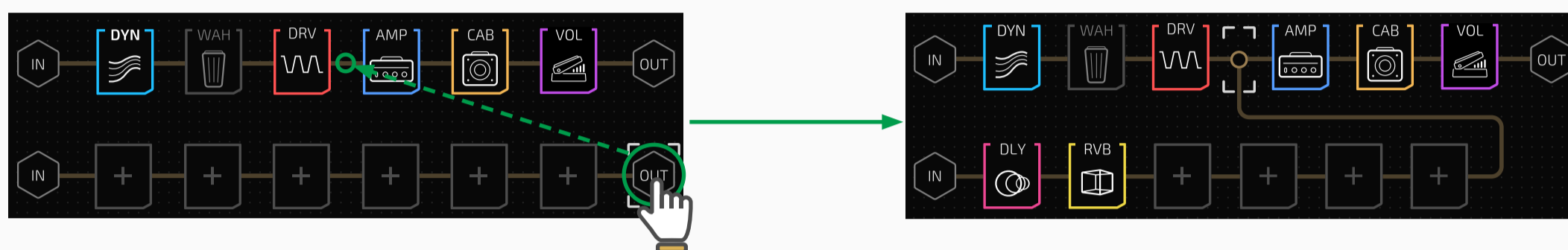

Change To Y-A/B

Drag and drop input node of chain B on chain A depending on your needs:

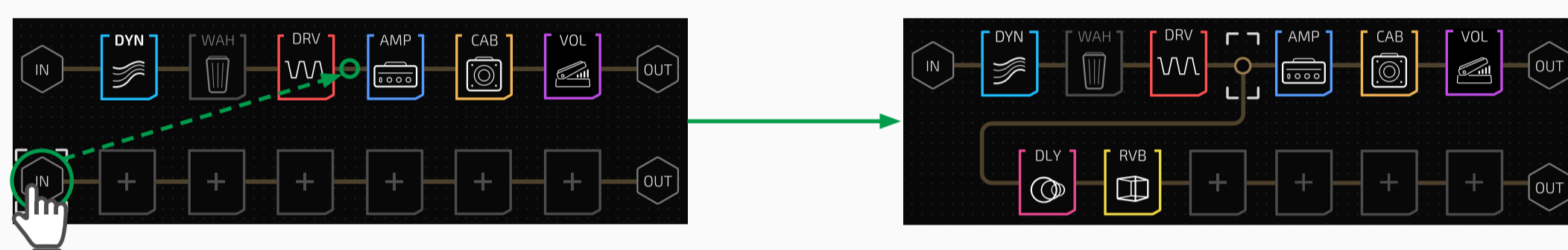

Change To Serial

Drag and drop input node of chain B to the output node of chain A:

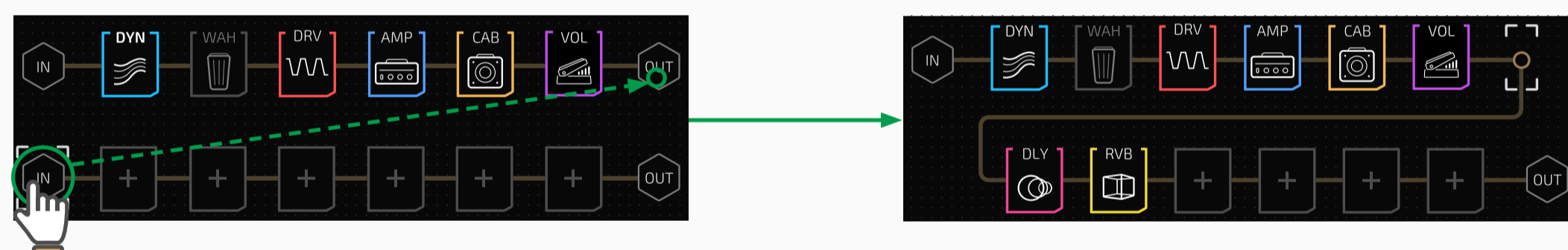

Change To Split-Mix

Drag and drop input and output nodes on chain A (between input and output nodes) depending on your needs:

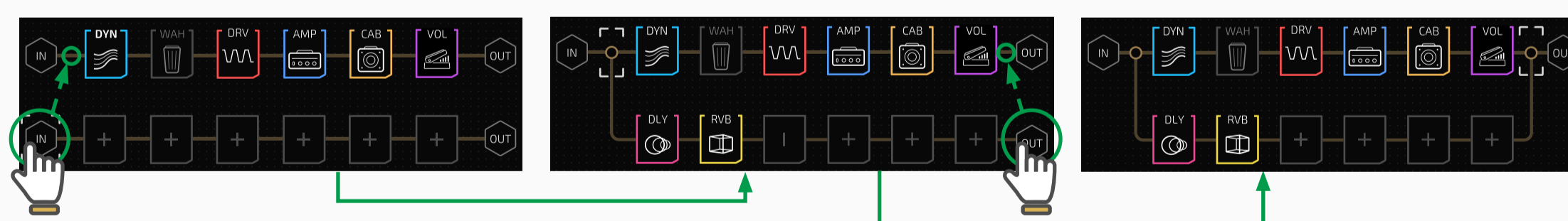

You can also operate by using Main Knob:

Turn Main Knob to a node – hold Main Knob to “pick up” a node – turn Main Knob to a place on chain A you need – press Main Knob to “put down”

Split/Mixer Node Settings

When using two chains, for best possible result, you need to carefully setup split and mixer nodes.

The texts next will you how to setup split and mixer nodes.

Split Node

Select a split node and the parameters will come up as shown below:

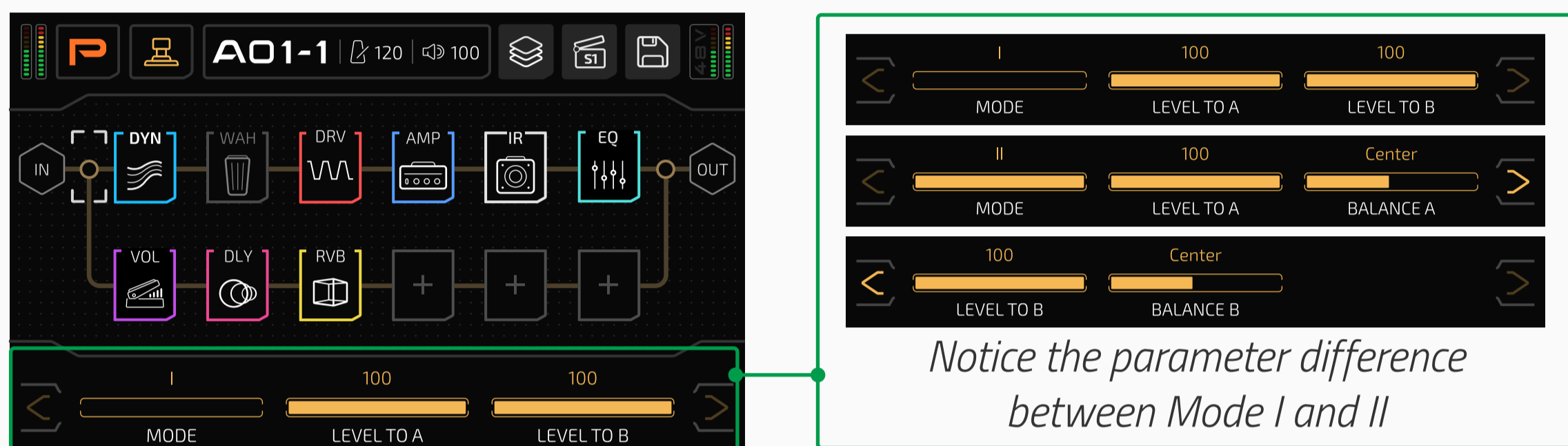

MODE lets you select a signal separation mode:

1. Mode I

In this mode the split node outputs **same** signals to both chain A and B as node input signal. If the split node is between slots containing effects with same signal I/O processing (all mono or stereo effects), this mode is recommended.

Use **LEVEL TO A/B** to set output level to A/B chains from 0~100, default is set to 100.

Please note: If you're mixing mono/stereo effects in slots around split node, the actual output may differ from what you expected. For example, use a stereo delay in the slot right before the split node with different delay settings on L/R channels, then use two mono filters in the slots right next to split node on both A/B chains, the result is you can only hear the delay settings on left channel. This is because effects with mono input use **left channel of input signal ONLY**.

For detailed signal I/O processing, please check **Effects List**.

2. Mode II

In this mode the split node will convert node input signal into dual mono signal and send it to both chain A and B. If the split node is between slots with mixed mono/stereo effects (e.g. one stereo effect in the slot right before the split node, two mono effects in slots right next to the split node on both chains for processing L/R outputs of the stereo effect), this mode is recommended.

Use BALANCE A/B to set output signal content (L/R ratio of node input signal) from L50 ~Center~R50, default is set to Center. Fine tune the parameter depending on your needs:

- BALANCE set to L50/R50 means only left/right channel of input signal will be sent to the slots next to split node
- BALANCE set to a value in between means a mixed signal will be sent to the slots next to split node; the value sets the mixing ratio, set to Center means mixing ratio=1:1

Use LEVEL TO A/B to set output level to A/B chains from 0~100, default is set to 100.

Please note: setting split node to Mode II only will NOT lead to a result like “left output is a kind and right is another”, since extra output/mixer nodes settings are needed.

Mixer Node

Select a mixer node and the parameters will come up as shown below:

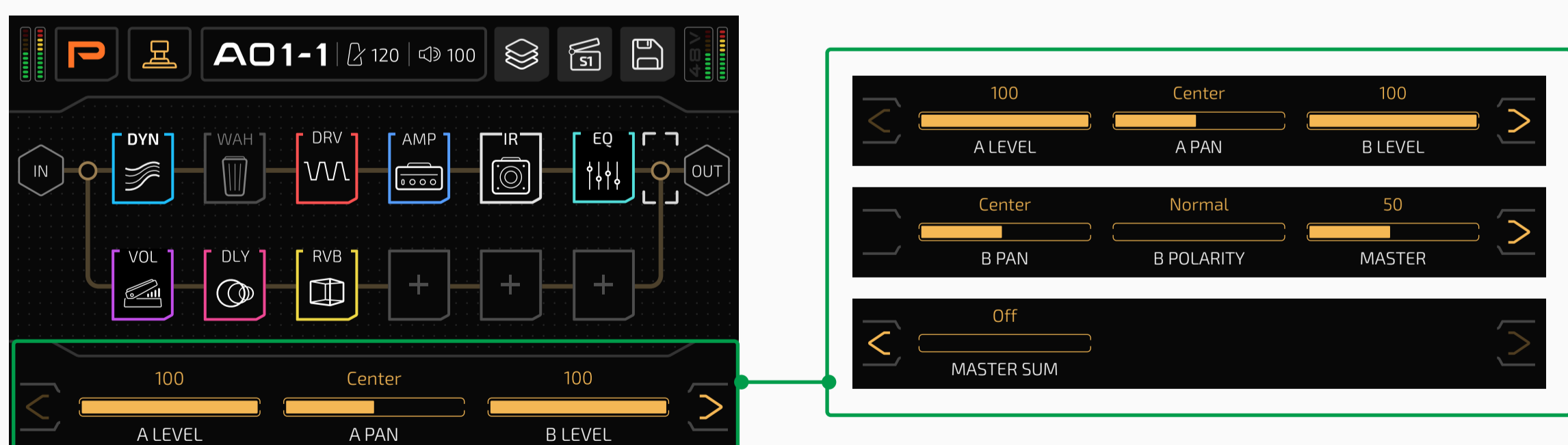

Use **A/B LEVEL** to set input level from A/B chains. The ranges are all 0~100, defaults are all set to 100.

Use **A/B PAN** to set input signal stereo panning from A/B chains. The ranges are all L50~Center~R50, defaults are all set to Center.

When you mix A/B chain signals, output may sound very sharp/thin/weak/muddy, even left and right outputs are L/R not balanced, this may be caused by signal **phase** issue. If mixed output sounds abnormal, you can set **B POLARITY** to reverse chain B signal phase and see if the problem solved or not. **B POLARITY** is set to Normal by default. Sometimes reversing chain B's phase may surprise you.

Use **MASTER** to set output level of mixer node. The range is 0~100, default is set to 50.

Turn on **MASTER SUM** switch to sum mixer node output to a dual mono output. Default is set to Off.

Please note:

1. When using stereo effects, in some cases, turning on MASTER SUM may lead to an abnormal output or even no output, this may be caused by L/R phase cancellation.
2. Please adjust A/B LEVEL and MASTER carefully to prevent signal clipping.

Effects Chain Templates

You can load built-in effects chain templates for quick setup, or save all your current effects chain settings (incl. chain type and node settings) as a user effects chain template.

All templates are global data that won't change when changing patches. You can load them anytime in any patch.

Press  button and the effects chain template menu will appear:

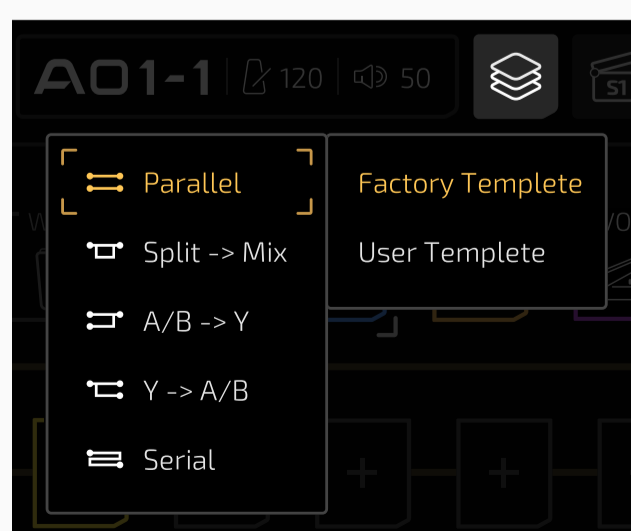

Factory Template submenu lets you choose from one chain type mentioned above. In factory templates, all split nodes are set between input node and slot A1, all mixer nodes are set between slot A6 and output node; all node settings are set to default.

User Template lets you choose from one of five user templates you saved before.

When you finished editing a chain, you can save its current chain type and node settings (slots/modules/effects are not included) as a user effects chain template so that you can recall anytime in any patch.

In FX Chain View, press  button and the save menu will appear. Then select Save Template to save your current effects chain settings as a template:



Slots and Modules Settings

Add a Module

Press any empty effect slot to enter Module/FX Select menu. This lets you add a module to a slot:

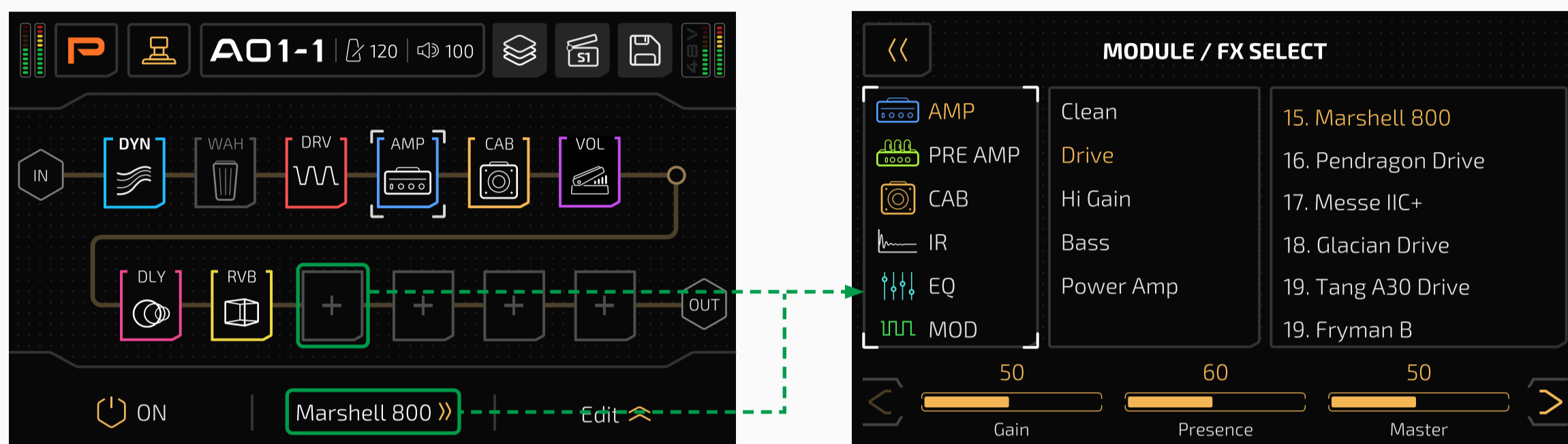

Move a Module

Drag and drop a module on an empty slot (or between slots):

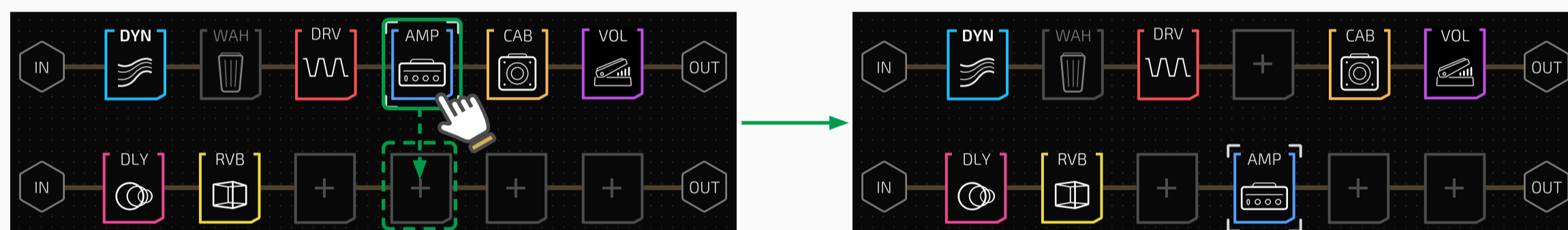

Or you can press and hold a module until module edit menu appear:

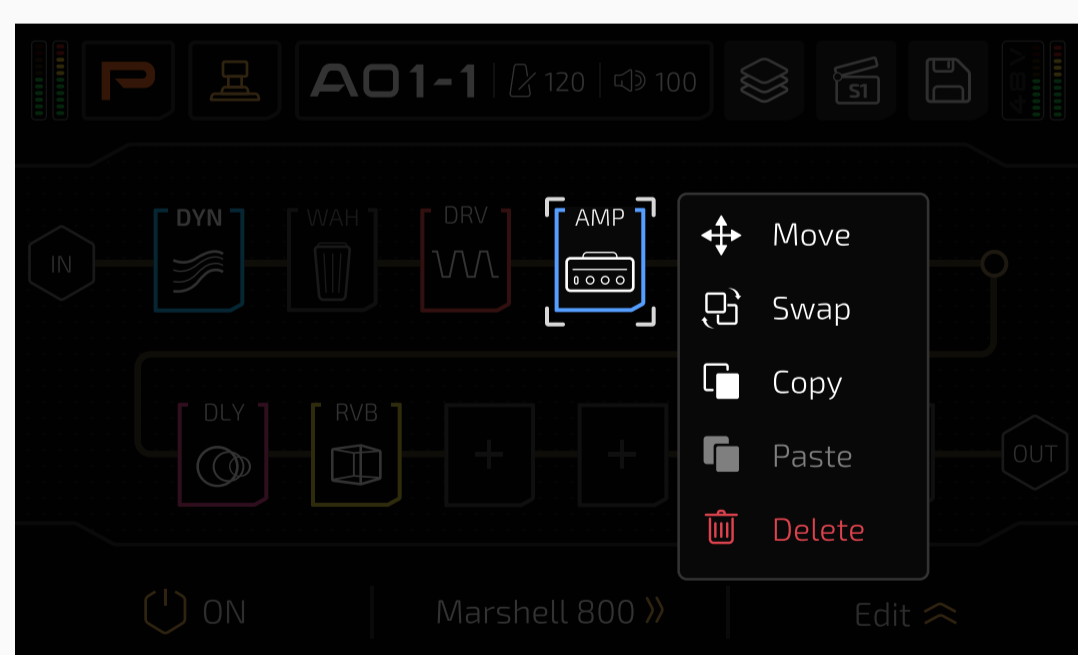

Select Move and choose a target slot by touchscreen or Main Knob:

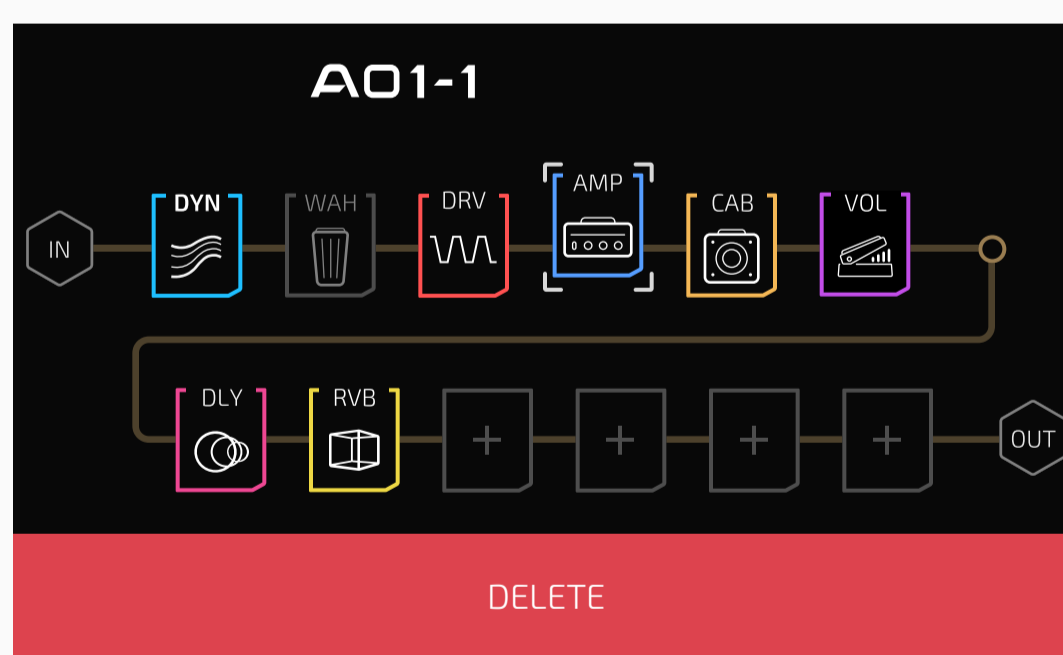

You can delete selected module by moving it to the red delete area as it appears on the bottom of the screen

Swap a Module

Drag and drop a module on the target module:

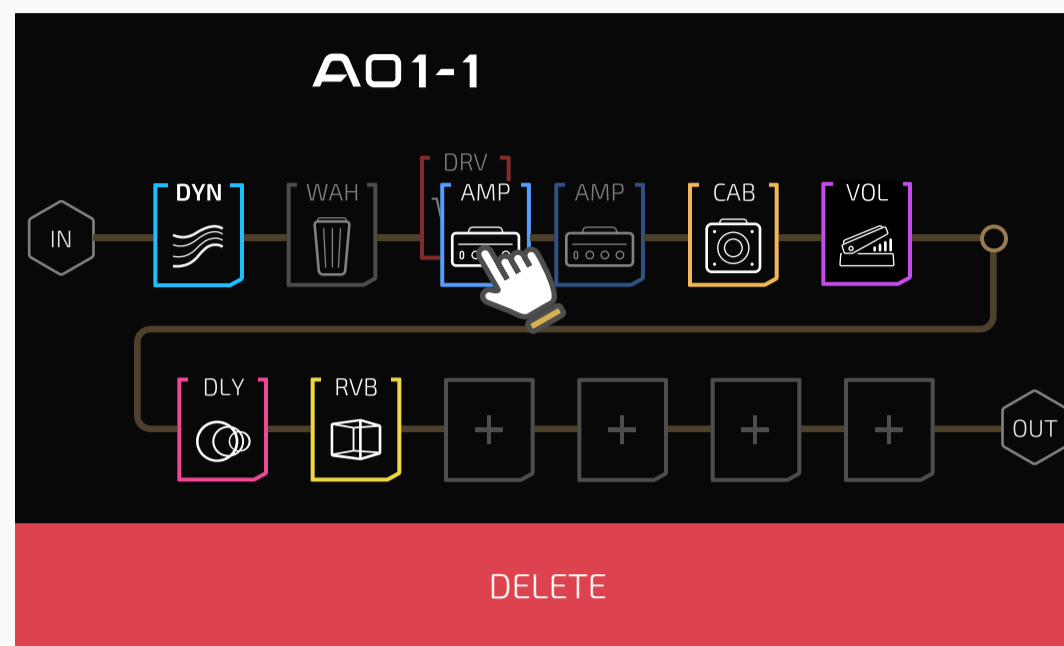

Or you can press and hold a module until module edit menu appear:

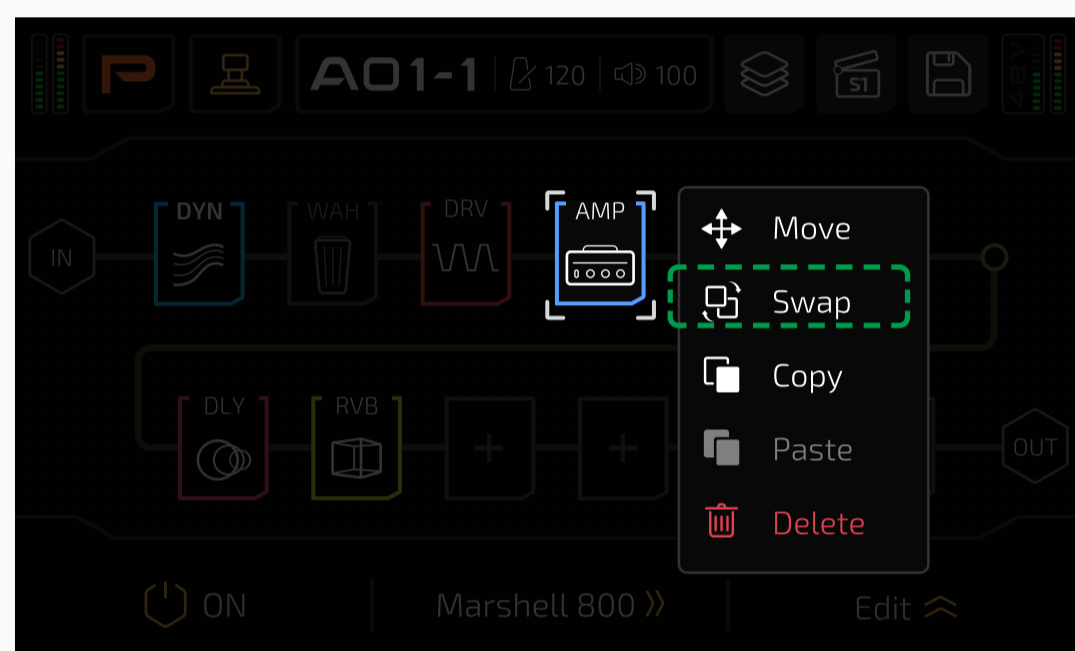

Select Swap and choose a target module by touchscreen or Main Knob:

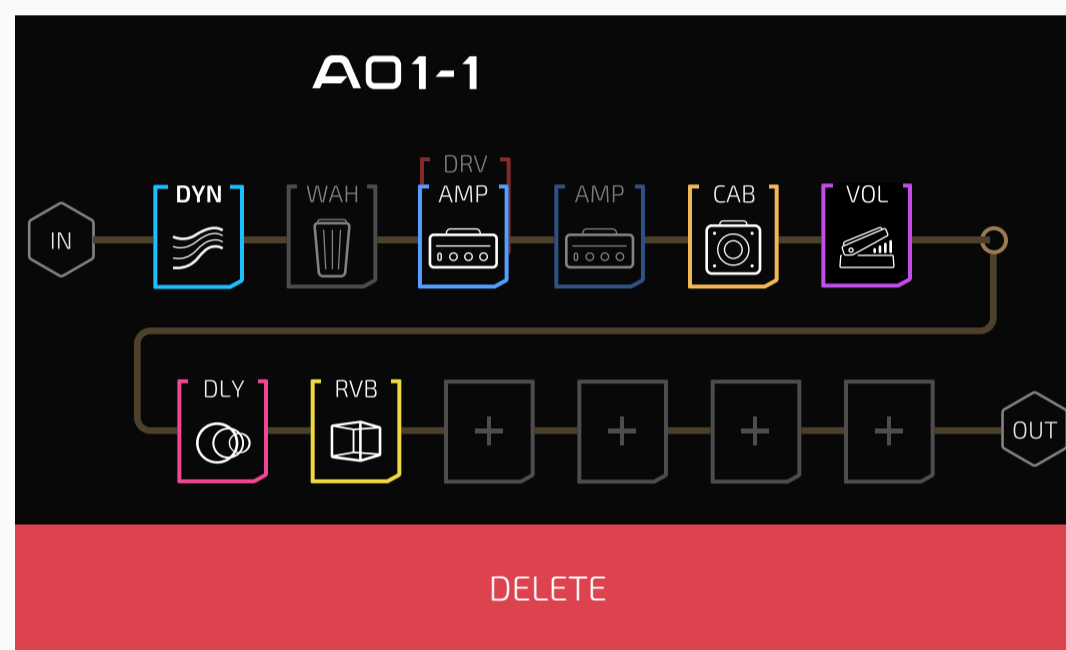

Copy/Paste a Module

You can copy a module (incl. current effect and parameter settings) and paste it repeatedly.

To copy, press and hold a module until module edit menu appear, then select Copy:

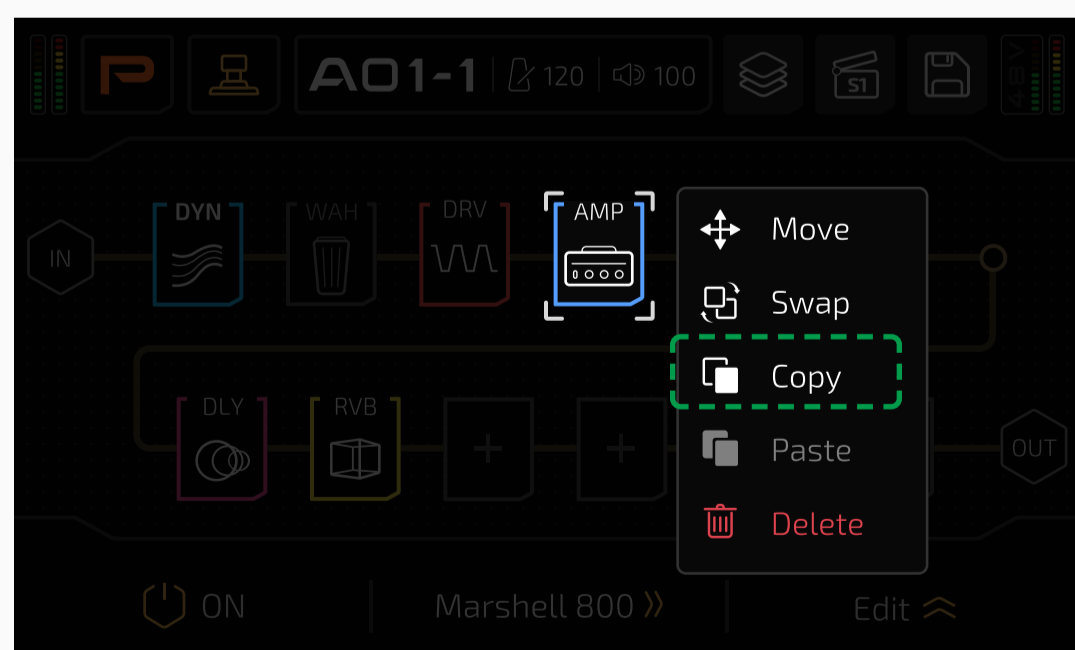

To paste, press and hold target slot until module edit menu appear, then select Paste:

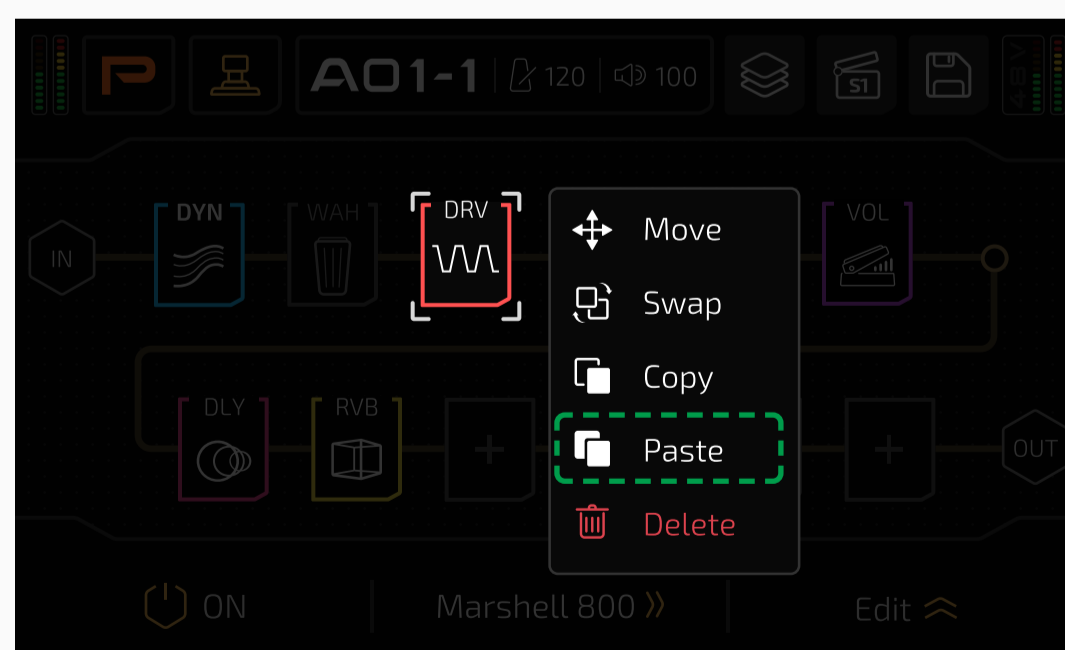

Reminder:

1. You need to copy before paste.
2. The copied module can be used in different patches.
3. The copied module data will be lost if the unit power is off.
4. If there already exists a module in target slot, pasting will overwrite existing data. A message will come up to indicate:

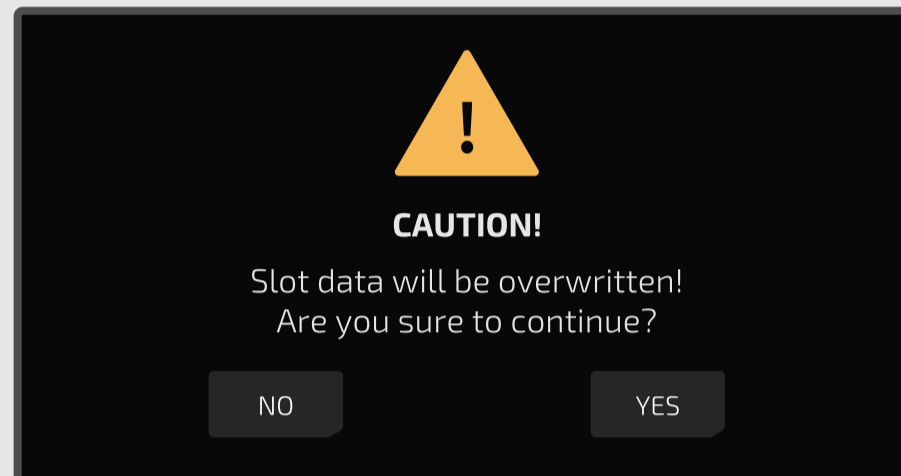

5. If you copied one other module with an existing copy, the previous data will be overwritten.

Delete a Module

Press and hold a module until module edit menu appear, then choose Delete:

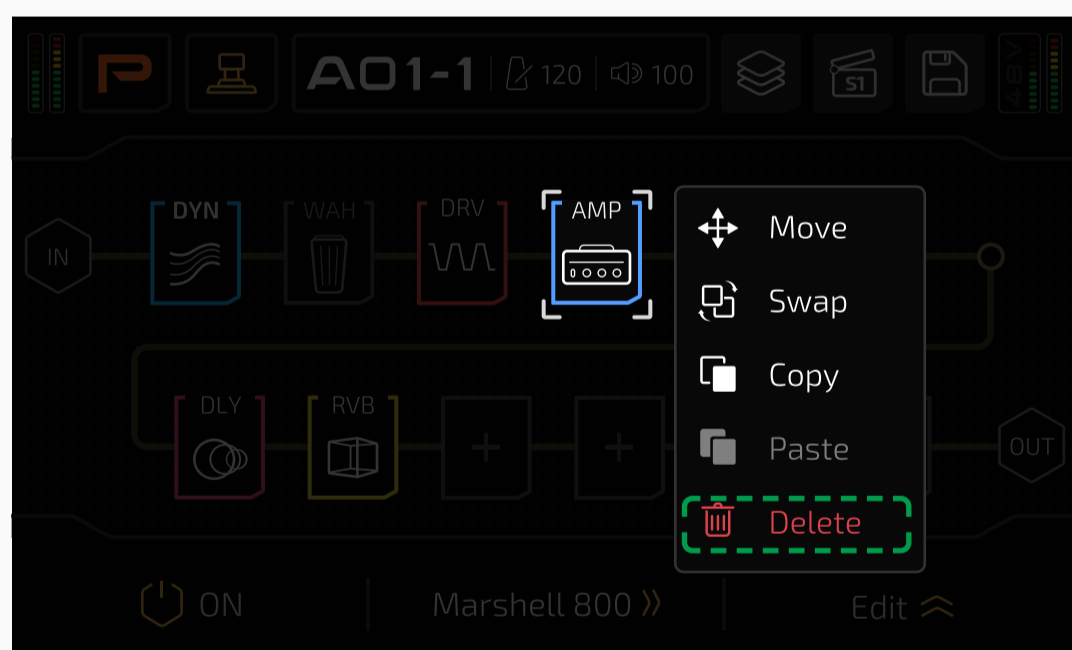

When moving/swapping modules, the red delete area also appears. So you can also drop the module to the area to delete the selected module.

Effects Settings

In FX Chain View

In FX Chain View, select a slot loaded with a module, and parameter list will show as below:

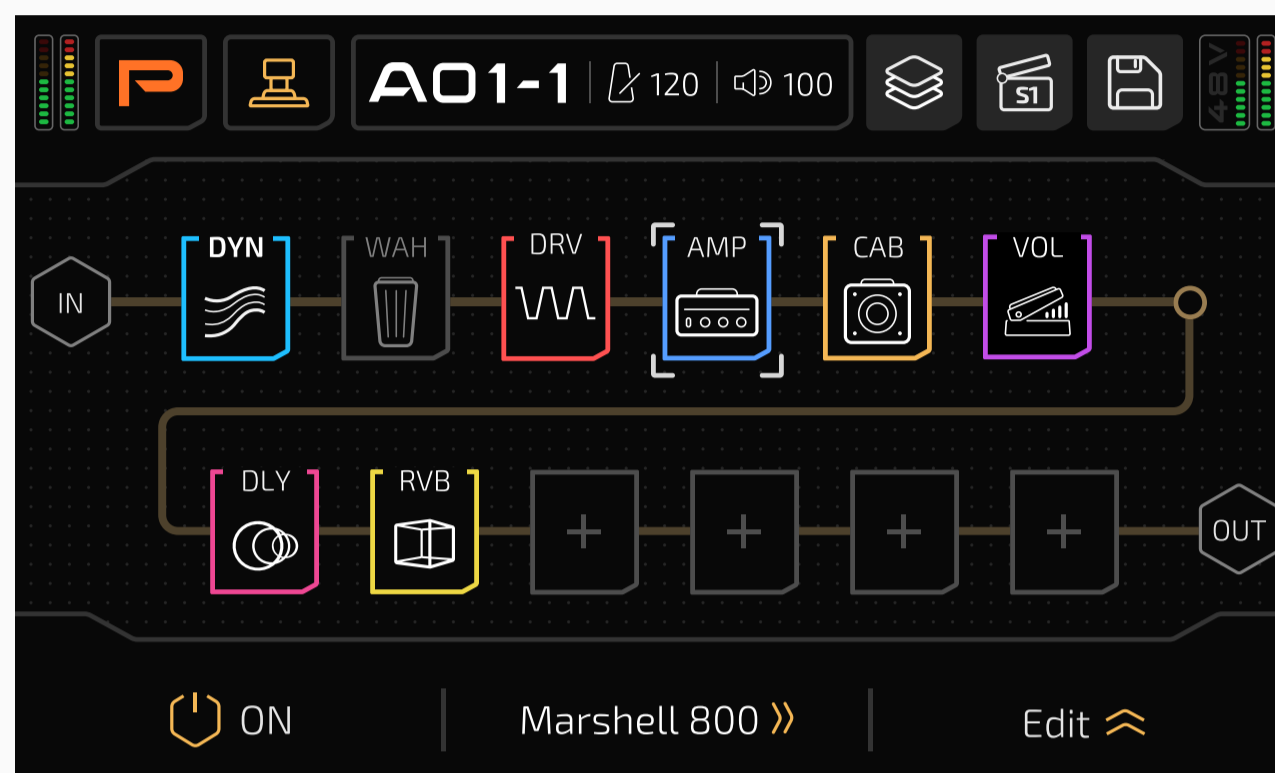

Press **ON** switch or use quick access knob 1 to turn the selected slot on/off.

Press **Marshall 800** to switch current effect in this module.

Press **Edit** button to expand available parameters of current effect:



Press **Edit** button again to collapse:

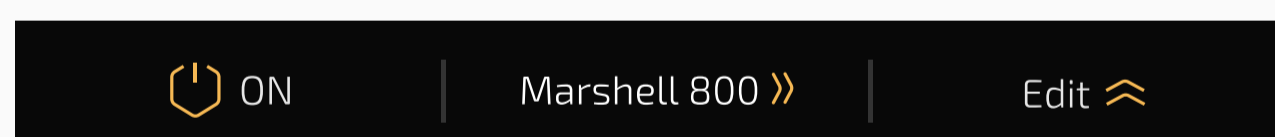

In FX Chain View you can't change module in selected slot.

In Module/FX Select Menu

You can press current effect name to enter Module/FX Select menu:

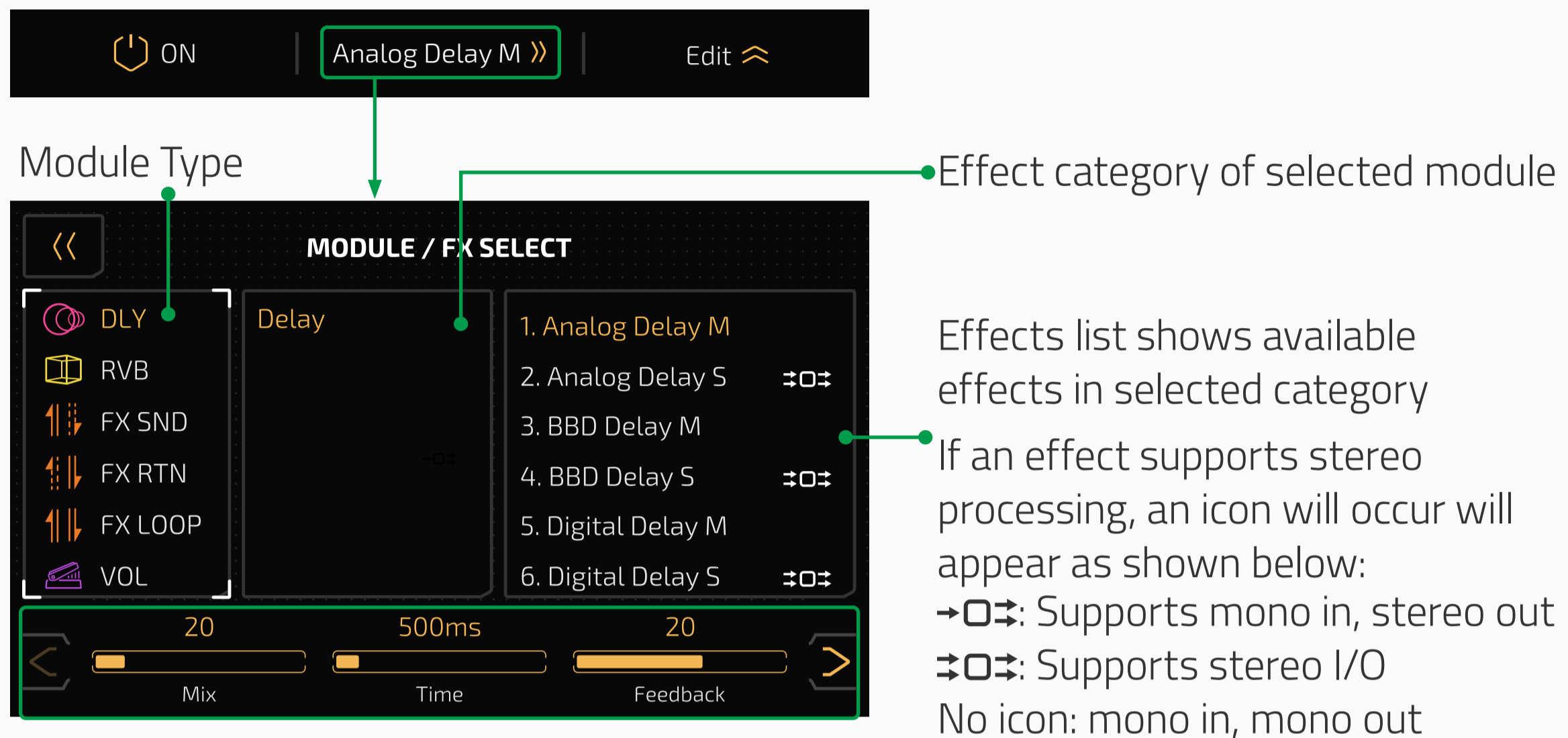

If the selected effect has more than three adjustable parameters, there will be an arrow at the right of the parameter panel. Press the arrow to see the other parameters.

In this menu, you can't turn current slot on/off.

For more information on modules, effects, and parameters, refer to Ampero II Effects List document.

Tap Tempo and Tap Divide

If you want a certain effect to be controlled by tap tempo, go into the patch settings, select an effect, then select SYNC. When you do this, the time will sync to the tap tempo value.



You can also opt to use tap divide rather than time-based tempo. The default tap divide is set to quarter notes (1/4).

Set the tempo by repeatedly tapping the footswitch. This tempo will apply to the delay time and other effects with adjustable speed parameters.

Tap divide values in relation to their musical beats are shown below:

Time Value	Beats	Display
Whole note	4	1/1
Half note	2	1/2
Dotted half note	3	1/2D
Half note triplet	4/3	1/2T
Quarter note (no divide)	1/1	1/4
Dotted quarter note	3/2	1/4D
Quarter note triplet	2/3	1/4T
Eighth note	1/2	1/8
Dotted eighth note	3/4	1/8D
Eighth note triplet	1/3	1/8T
Sixteenth note	1/4	1/16

To use tap tempo function you can:

1. Switch to Stomp Mode, assign Tap Tempo function to one of footswitch 1-4; when in Tap Tempo, the footswitch LED will turn blue and will flash with the tempo set
2. Apply a momentary footswitch and assign Tap Tempo function
3. Use MIDI controller (see MIDI Information List document)

To setup built-in footswitches please go to **Patch Settings** section;

To setup external footswitches, please go to **GLOBAL** section.

Effects with Tap Tempo support are mostly modulation (MOD module), delay (DLY module) and auto filter (FREQ module) effects. See Effects List for details.

DSP Power and Overload

Different effects have different DSP power requirements. So, as more and more modules/effects are added, some of the module/effect names will turn grey and become unavailable. This indicates remaining processor power is not enough to handle these modules/effects, which is normal.

In some extreme cases the signal processor may become overloaded and display this caution:

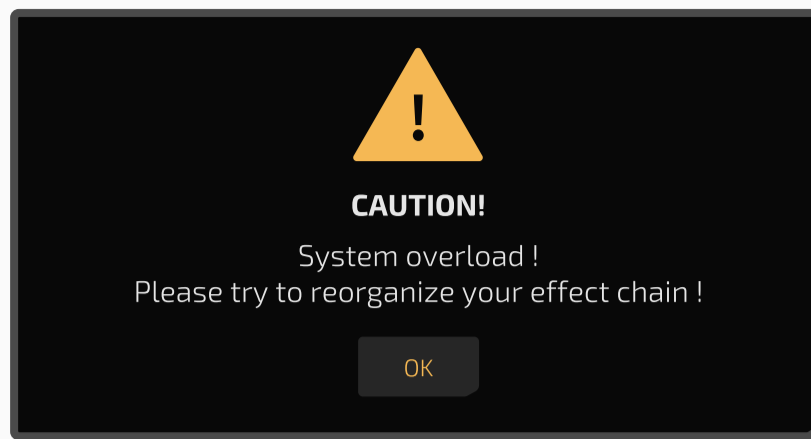

If this happens (the effect output is probably abnormal), try changing out some of the effects modules/node positions/chain types, move modules back or to another position, delete unnecessary modules, etc.

Using FX Loop

To use unit's FX loop jacks you need to:

1. Assign input source/output destination to FX loop jacks (see **Input Node Settings** section, **Output Node Settings** section and **USB Audio** section)
2. Add a FX loop related module (FX SND/RTN/LOOP)

Next we will show you how to setup an FX loop related module.

FX SND (FX Loop Send)

The FX SND module will send the received signal from previous slot/node to FX Loop Send jack:

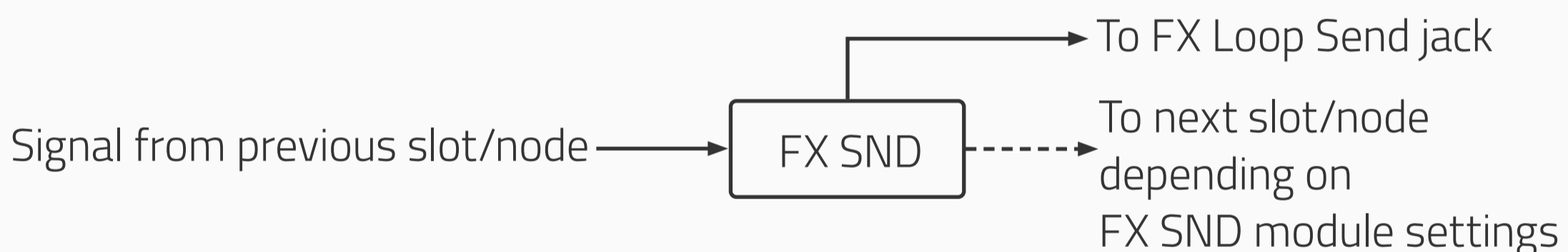

Available parameters are shown below:

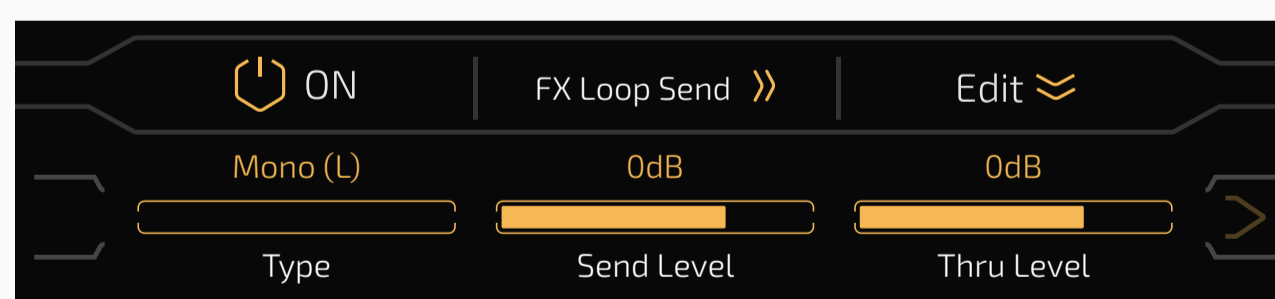

Use **Type** to select input signal processing type:

- Mono (L): Mono I/O configuration, receives left channel of input signal only
- Mono (R): Mono I/O configuration, receives right channel of input signal only
- Stereo: Stereo I/O configuration

Use **Send Level** to adjust output level to FX Loop Send jack from Mute ~ -60dB ~ +20dB, default is set to 0dB.

Use **Thru Level** to adjust output level to next slot/node from Mute ~ -60dB ~ +20dB, default is set to 0dB.

FX RTN (FX Loop Return)

The FX RTN module will send the received signal from FX Loop Return to next slot/node:



Available parameters are shown below:

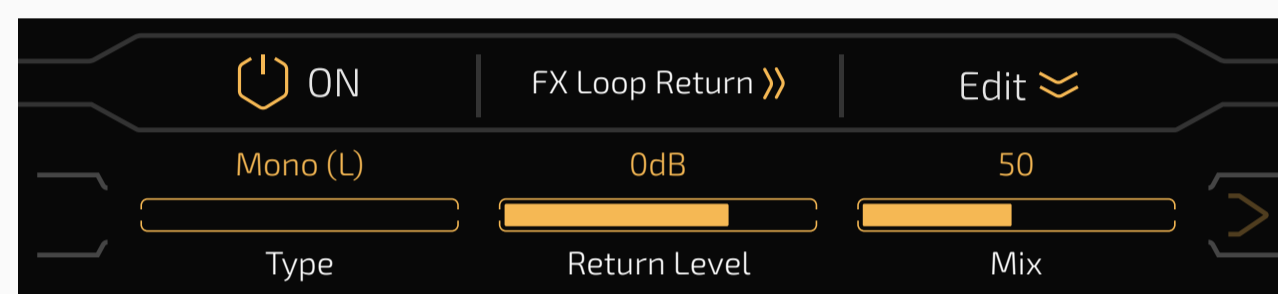

Use **Type** to select input signal processing type:

- Mono (L): Mono I/O configuration, receives left channel of input signal only
- Mono (R): Mono I/O configuration, receives right channel of input signal only
- Stereo: Stereo I/O configuration

Use **Return Level** to adjust input level from FX Loop Return jack from Mute ~ -60dB ~ +20dB, default is set to 0dB.

Use **Mix** to adjust signal ratio between signal from previous slot/node and signal FX Loop Return jack. The range is 0~100, default is set to 50.

When **set Mix to 0**, only signal from previous slot/node will be sent.

When **set Mix to 100**, only signal from FX Loop Return jack will be sent (this also means all slots/nodes before FX RTN jack will be disabled).

FX LOOP

The FX LOOP module sends signal from previous slot/node to FX Loop Send jack and signal from the FX Loop Return jack to next slot/node. When using with external devices, this module will “insert” the external device connected to FX Loop jacks to an effects chain:

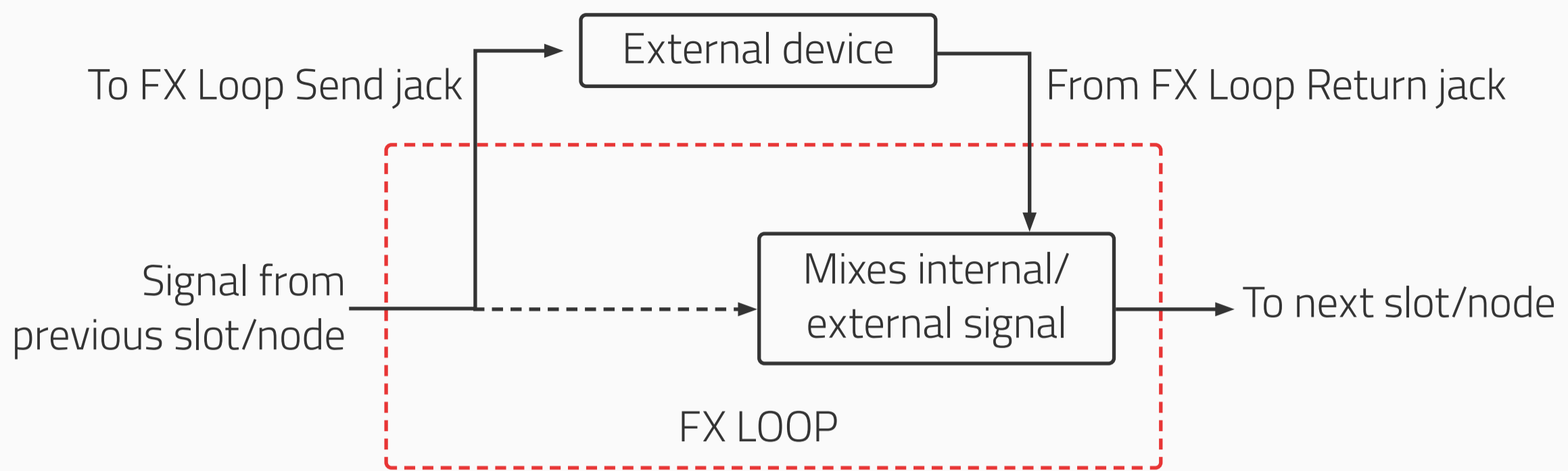

Available parameters are shown below:

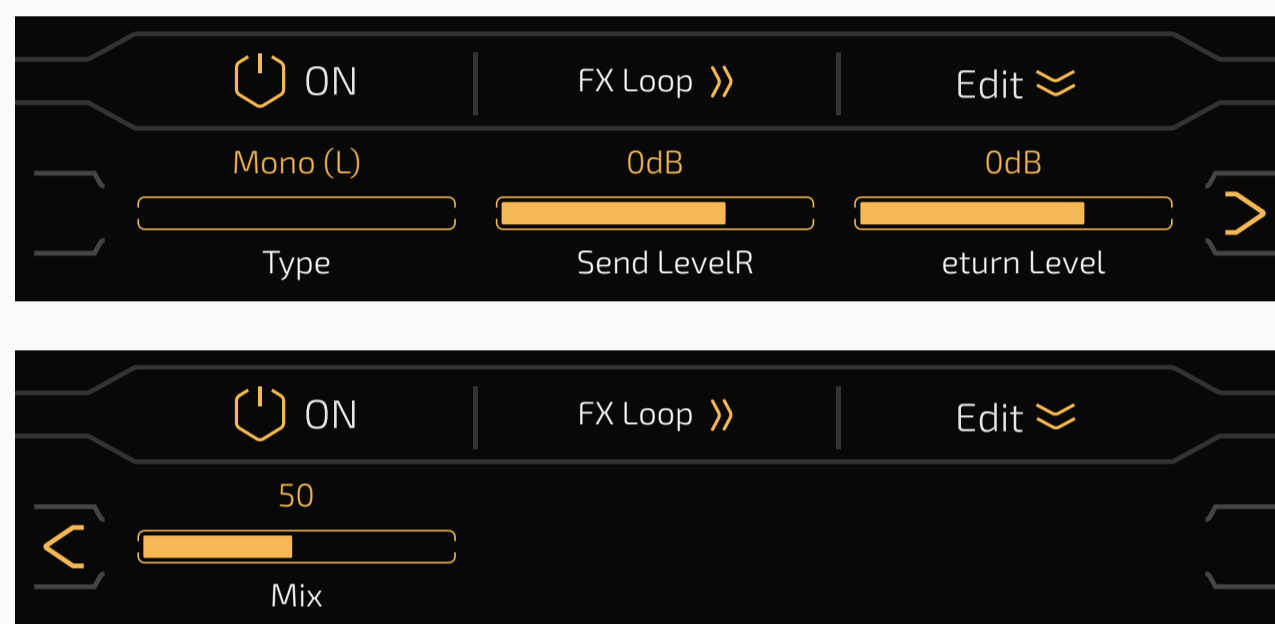

Use **Type** to select input signal processing type:

- Mono (L): Mono I/O configuration, receives left channel of input signal only
- Mono (R): Mono I/O configuration, receives right channel of input signal only
- Stereo: Stereo I/O configuration

Use **Send Level** to adjust output level to FX Loop Send jack from Mute ~ -60dB ~ +20dB, default is set to 0dB.

Use **Return Level** to adjust input level from FX Loop Return jack from Mute ~ -60dB ~ +20dB, default is set to 0dB.

Use **Mix** to adjust signal ratio between signal from previous slot/node and signal FX Loop Return jack. The range is 0~100, default is set to 50.

When **set Mix to 0**, only signal from previous slot/node will be sent.

When **set Mix to 100**, only signal from FX Loop Return jack will be sent.

Serial And Parallel FX Loop

- A Serial FX Loop means external device is connected to other effects chain in series:

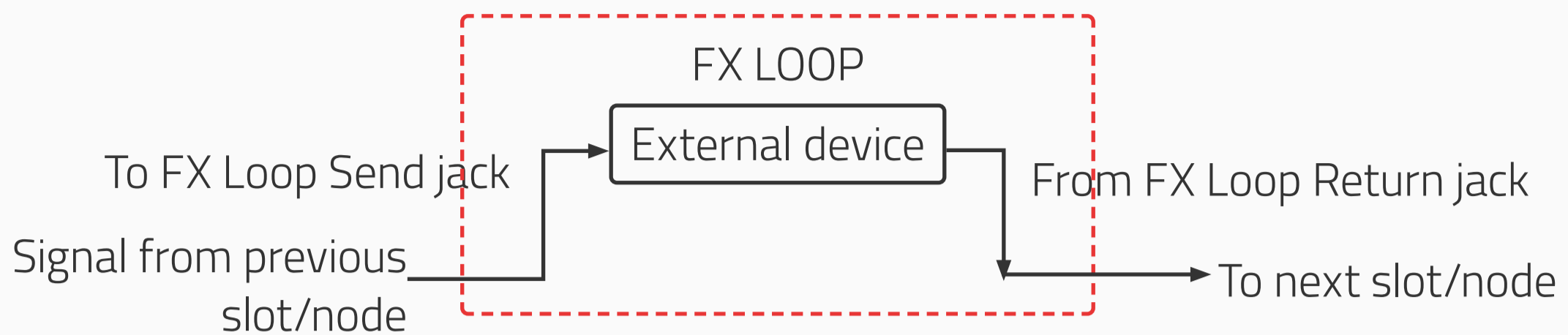

- A Parallel FX Loop means external device is connected to other effects chain in parallel:

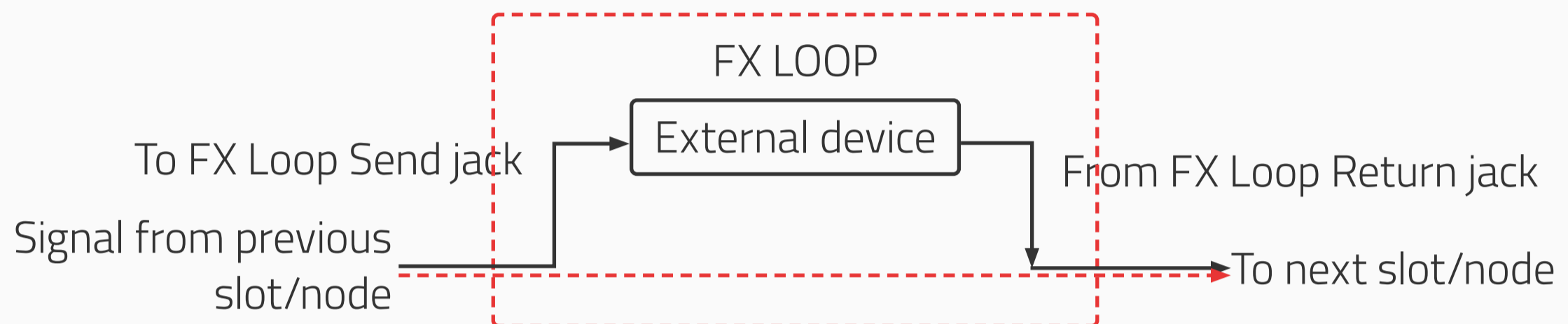

Ampero II supports both serial and parallel FX loop connection. Fine tune the parameters depending on your needs:

- Use as a serial FX loop
 - FX SND: Set **Thru Level** to 0
 - FX RTN and FX LOOP: Set **Mix** to 100, and **Send Level** cannot be muted
- Use as a parallel FX loop
 - Set the parameter values differ from mentioned above; we recommend to keep default settings

Reminder:

When using FX SND/RTN/LOOP modules, please be careful to prevent from abnormal operations (putting FX RTN module before FX SND module/use more than two FX LOOP modules in an effects chain, using FX SND/RTN/LOOP modules while setting input/output node source to FX Loop jacks, etc.) which may cause abnormal noise, even unit malfunction.

Patch Tempo and Volume

In any mode, press  button to adjust patch volume from 0 to 100:

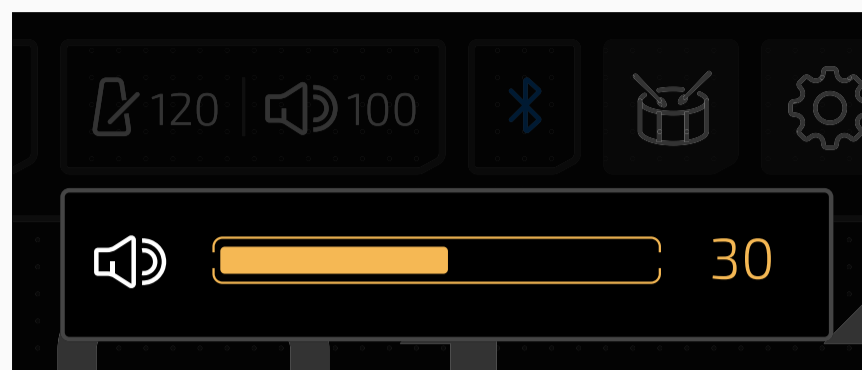

Press  to input patch tempo from 40BPM to 300BPM:

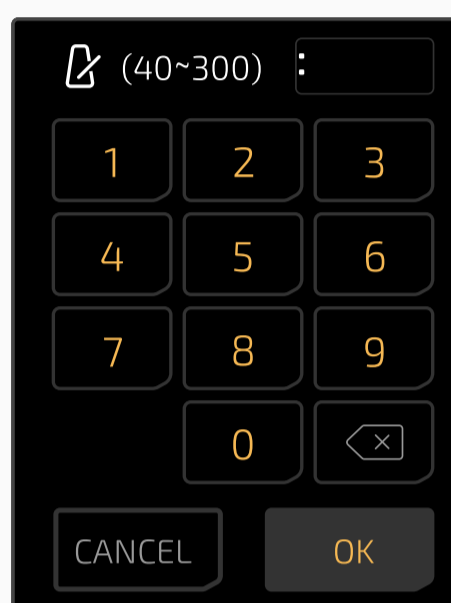



Patch tempo and volume will change depending on patch settings.

Scenes

You can use scene function for gap free effect switching, natural delay/reverb trail spillovers and setting different parameter combinations for different parts of your songs. Ampero II supports up to 4 scenes in a patch. Whenever you select a patch, the default scene selection will always be Scene 1.

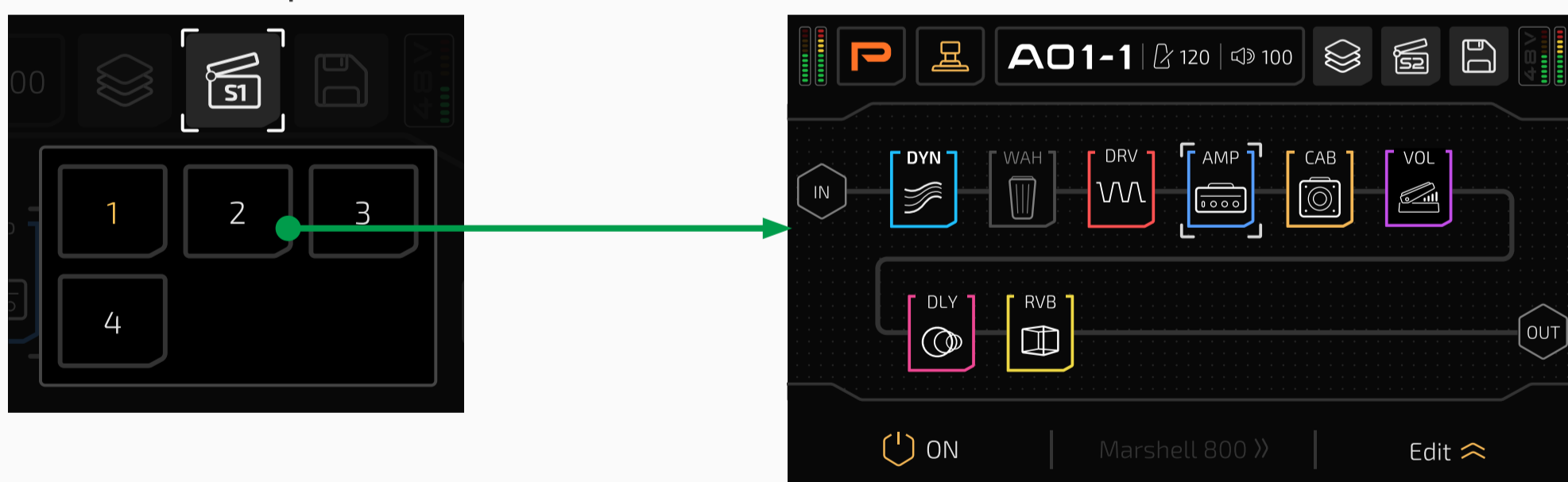
In FX Chain View, press  to select a scene to edit:



In scene 2-4, you can only edit slot on/off status, parameters of current effects you're using, patch tempo and patch volume. In this case, when you need to edit effect parameters, select a target module, and press  button:



Notice that effect selection button is greyed out, indicating function unavailable

Reminder:

1. Scene 2-4 settings will be temporarily saved when you switch to another scene in current patch.
2. After editing a scene, if you switch to another patch, all scene settings will be lost. Please remember to save first.
3. If you're starting with a new patch, settings in Scene 2-4 will be the same as Scene 1 until you edit them.
4. If you change a parameter of the effect module in Scene 2-4, that parameter will be displayed in white, indicating that it is not synchronized with Scene 1. By adjusting this parameter to match the value in Scene 1, the parameter will restore synchronization with Scene 1 and be displayed in the system theme color.
5. If you edited effects chain, nodes, slots/modules, effects in Scene 1, the changes will also apply to Scene 2-4, which will overwrite your previous scene settings.
6. Saving a patch will also save all scene settings of current patch.

Patch Settings

Use the Patch Settings menu to determine footswitch functions (Stomp Mode), quick access para targets, and setup the expression pedal parameters.

Remember that all the control settings will change as you change patches. If you switch patches or turn the unit off before saving your changes, the changes will be lost. Make sure to press **SAVE** on the upper right of the display screen to save your settings.

In Footswitch View, press  button to enter Patch Settings menu:

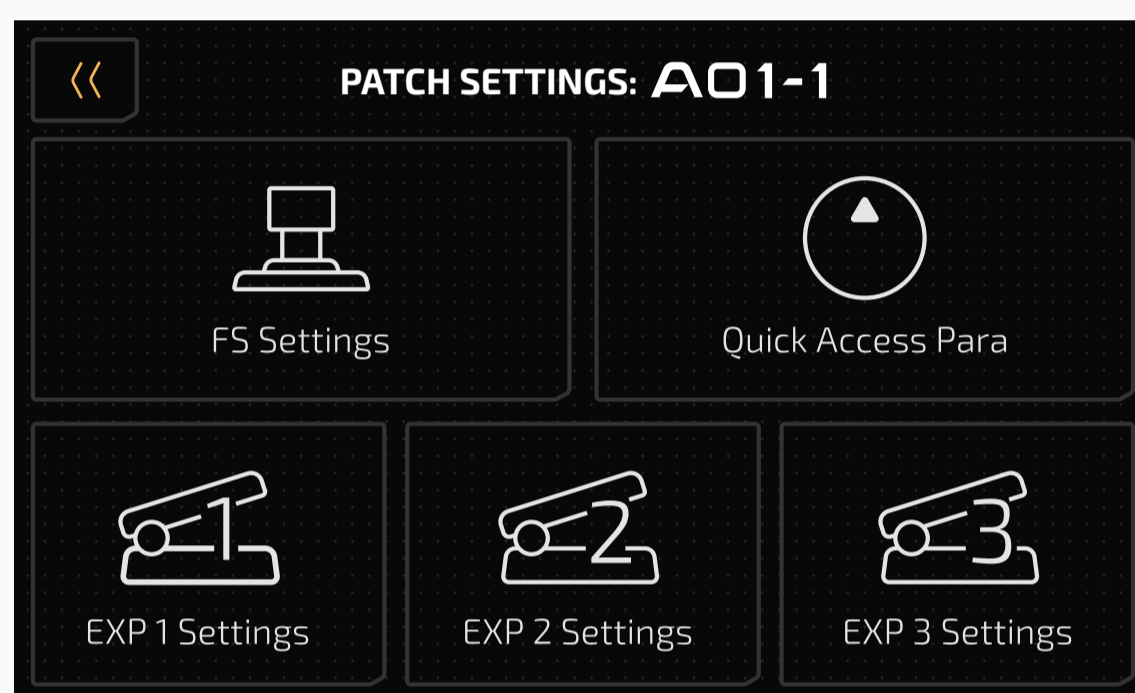

FS Settings

This menu allows you to set the footswitch functions in Stomp Mode under the current patch.

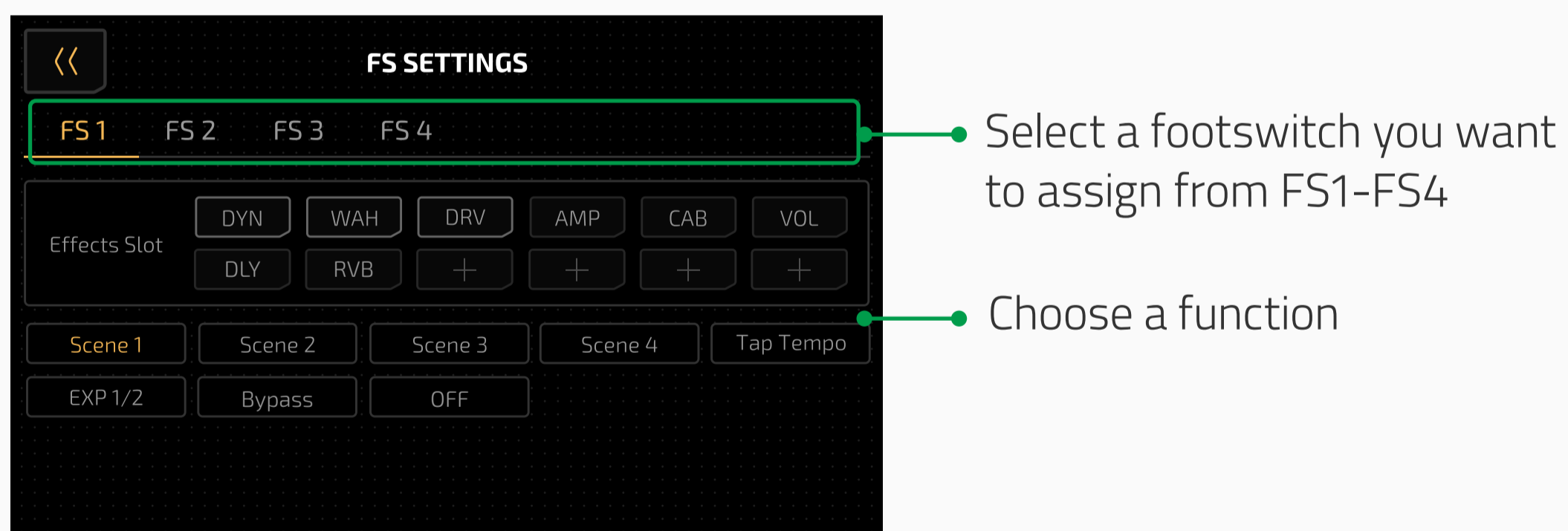

You can only assign one function for each footswitch. The available functions are:

- **Effect Slot:** For switching one or multiple slots on/off. When you select one slot, the footswitch LED color depends on the module you assigned to the corresponding slot; when you select more than one slot, the footswitch LED color will be fixed to orange/blue toggle.

- Scenes 1-4: Choose a scene of current patch.
- Tap Tempo: Execute tap tempo for controlling time-based effect parameters.
- EXP 1/2: Toggle between expression pedal 1/2.
- Bypass: Bypass the unit.
- OFF: No function.

Function, module and footswitch color are listed below:

Function/Module	Color
DYN, EQ	Cyan (LED on=slot on, LED off=slot off, same below)
FREQ, AMP	Blue
WAH, VOL	Purple
DRV, DLY	Red
IR	White
PRE AMP, MOD	Green
CAB, RVB	Gold
FX SND/RTN/LOOP	Orange
Effect Slot (Multiple Selection)	Orange/Blue
Tap Tempo	Flashing Blue
EXP 1/2	Orange (EXP 1)/Blue (EXP 2)
Scenes 1-5	White Solid
Bypass	No Color

Quick Access Para

This menu allows you to set the three quick access parameters of current patch in main menu. The targets can be all effects parameters used in the current patch, patch volume, patch tempo and input level.

If you don't want the quick access para on, select None to turn its function off.

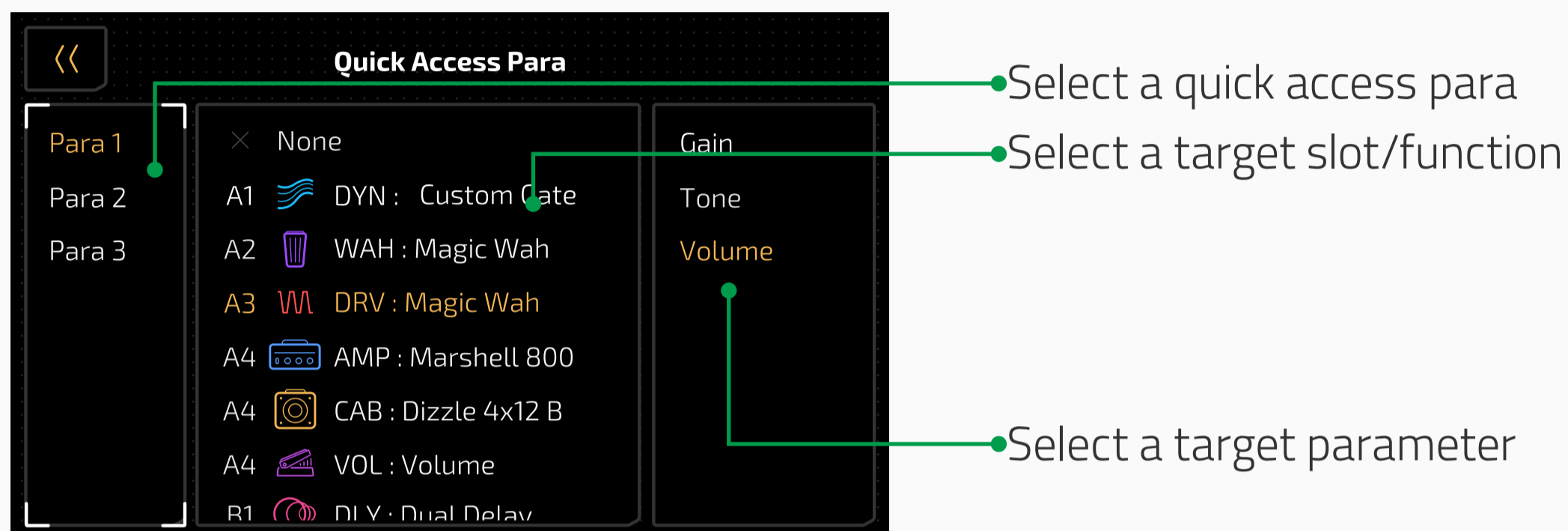

The available selections depend on the modules/effects used in the current patch. Please refer to **Effects List** for more info.

If there is no module/effect, the available selections are NONE, Patch Tempo, Patch Volume and Input Level A only.

If the target module is edited (moved, deleted, effect replaced, etc.), the quick access para will default to None.

You can also enter this menu by holding any quick access para (available in Patch Mode and Footswitch View). In this case, when you press back button on top left, the unit will go back to Patch Mode/Footswitch View depending on your previous selection.

EXP 1-3 Settings

You have the option to use the built-in expression pedal or connect your own to control various effects parameters. From this menu, you can control the settings of the built-in expression pedal or external expression pedal.

To use an expression pedal to control parameters, please set EXP/CTRL 1/2 jack function to EXP 1/2 or EXP 3, and assign target parameters. If the current patch does not have any effect controllable by expression pedal or the expression pedal switch is off, the pedal will not function.

EXP 1 and 2 are designed as a group for applying on built-in expression pedal so you can press the pedal toe strongly to toggle between exp 1 and 2 functions (like wah/volume toggle or volume/pitch toggle).

To use an expression pedal to control parameters, please set EXP/CTRL jack function to **EXP 3** (see **Contrls** section), and assign target parameters. If the current patch does not have any effect controllable by expression pedal, the pedal will not function.

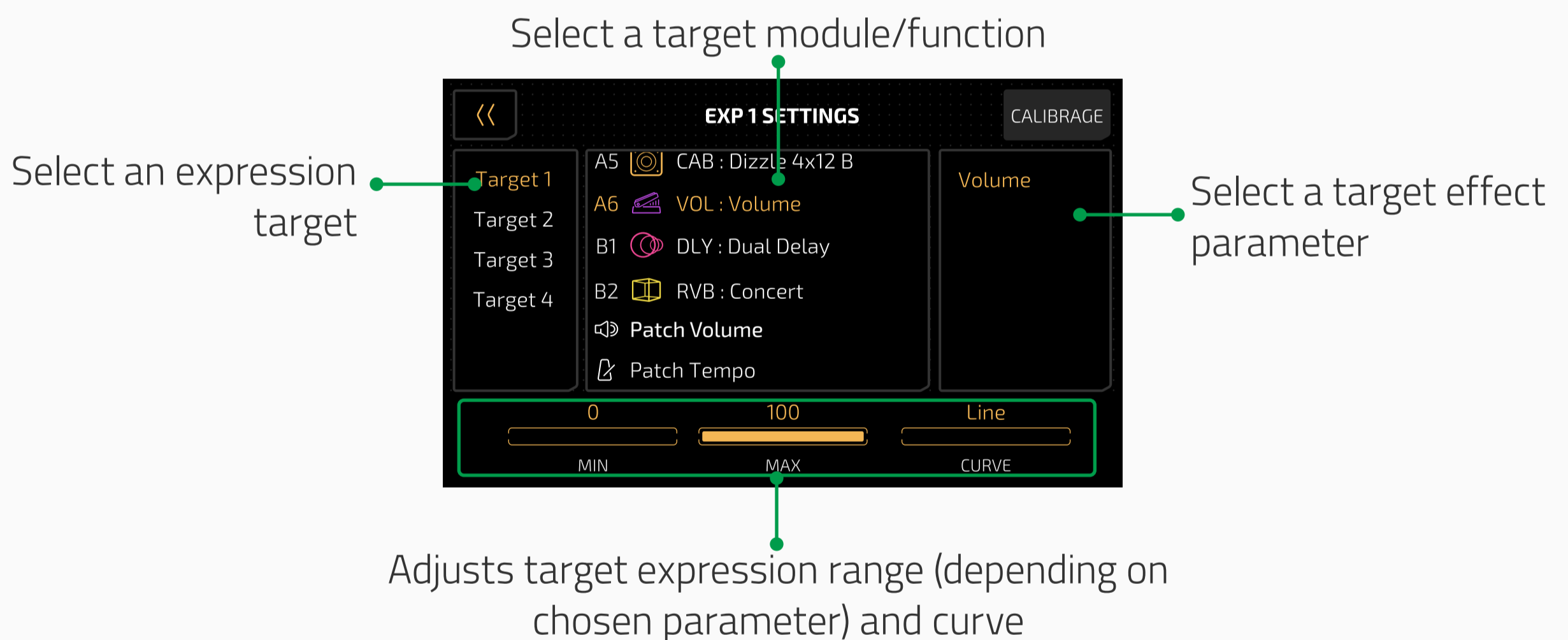

Target 1-4 let you set the pedal's control target. You can set up a maximum of four effect parameters/function targets for the expression pedal to control.

The available target selections depend on the modules/effects used in the current patch. The selectable parameters will vary with different effects.

Please refer to **Effects List** for more info.

If there is no module/effect, the available selections are None, Patch Tempo, Patch Volume only.

If the target module is edited (moved, deleted, effect replaced, etc.), the expression target will default to None.

MIN, MAX and **CURVE** options on the bottom lets you set the expression pedal expression range and sweep curve. There are four adjustable targets to change these settings.

MIN represents the lowest range value. This is the value the pedal will have when pushed all the way up.

MAX represents the highest range value, when the pedal is pushed all the way down.

CURVE represents the curve line the pedal will follow when pushed from all the way up to all the way down.

The MIN and MAX range is the same as corresponding effect parameter, and the MIN value can be greater than the MAX value.

There are three CURVE types:

- Line follows a straight line
- Exp follows an exponential line from slow to fast
- Log follows a logarithmic line that changes as the pedal moves

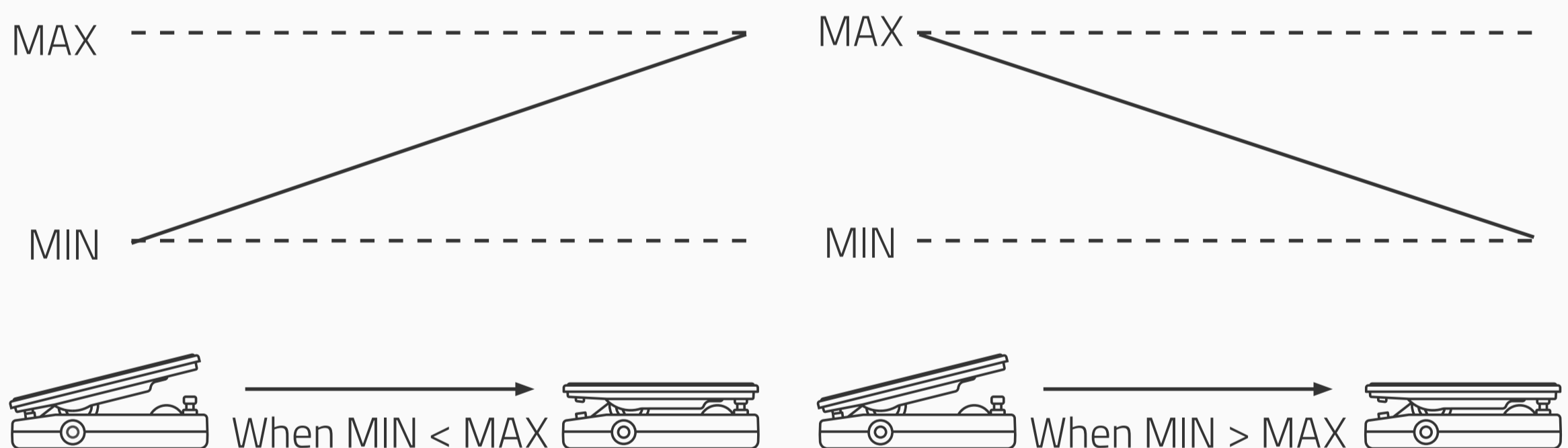

If you don't want the expression pedal on, select NONE to turn its function off.

For EXP 1/2, you can also enter this menu by holding EXP 1/2 icon (available in Patch Mode and Footswitch View). In this case, when you press back button on top left, the unit will go back to Patch Mode/Footswitch View depending on your previous selection.

Calibrate

The Calibrate option helps you calibrate your expression pedal. It is important to calibrate the expression pedal if you find the sweep has very little or too much change in the effect you've set.

Press Calibrate on the selection panel, and these instructions will appear:

Bring the pedal all the way up (back) and press NEXT.

Then press the pedal all the way down towards toe and press NEXT.

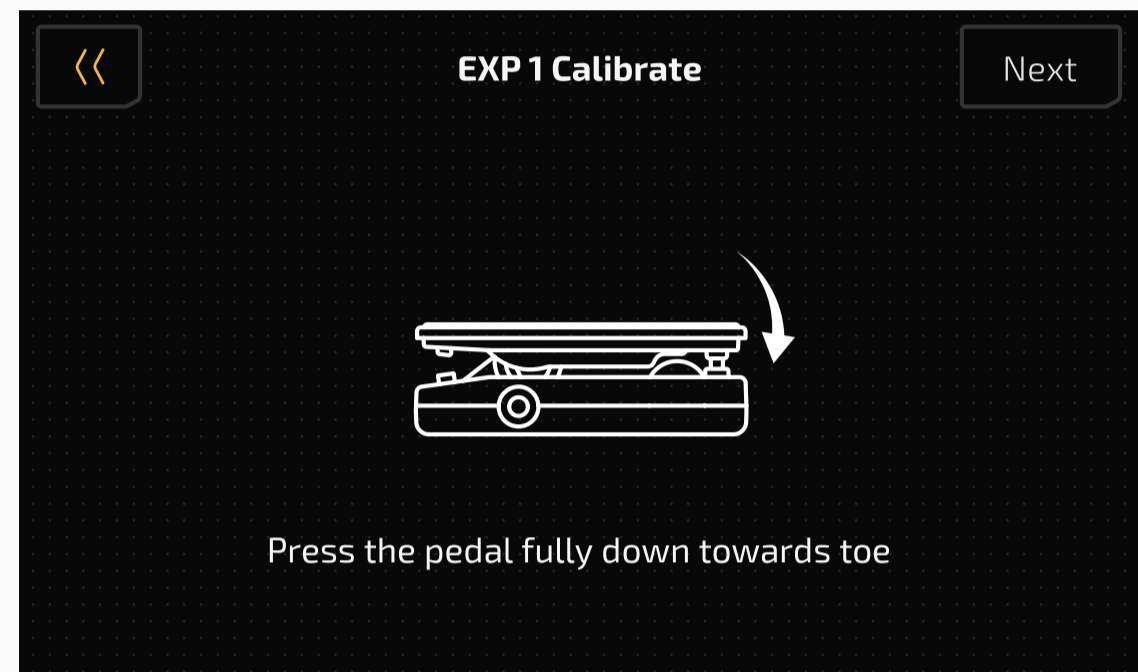
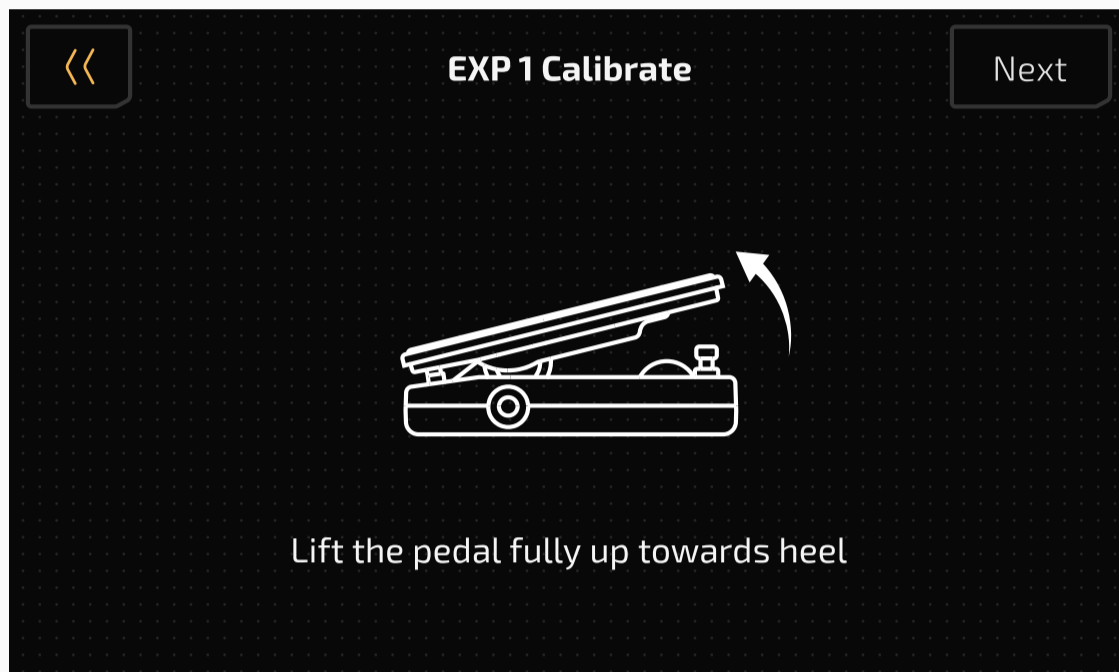

Then, strongly press the pedal toe down and press NEXT.

The calibration will be set, and this message will appear:

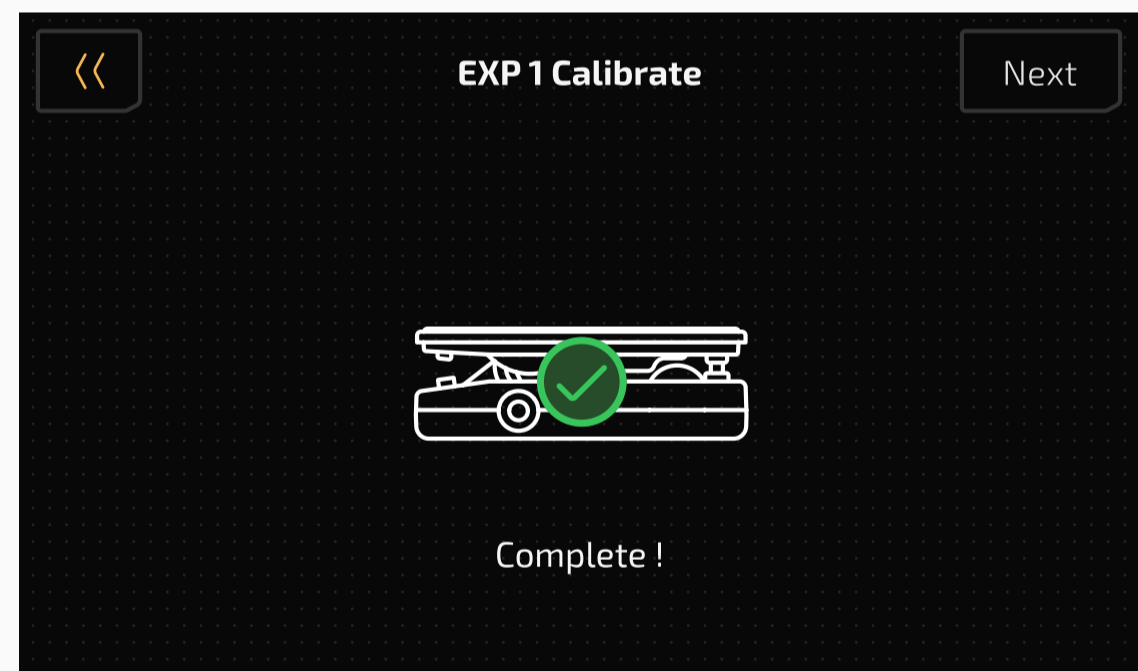

(EXP 3 don't need)

Press BACK to return to the previous menu.

If the calibration fails, this message will appear:

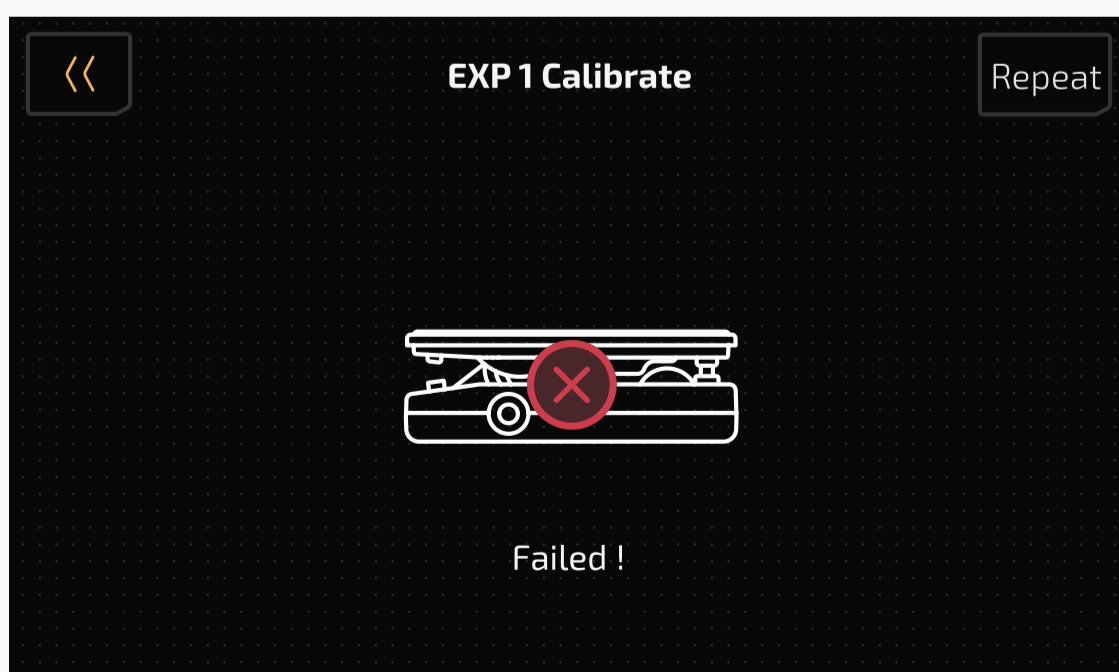

Press REPEAT to begin the calibration process again.

SAVE

You can save the changes you made to your effects parameters, control information, scene settings and other editable targets.

It is very important to save the changes you made to your tone and control settings!

In FX Chain View, press  button and the save menu will appear:

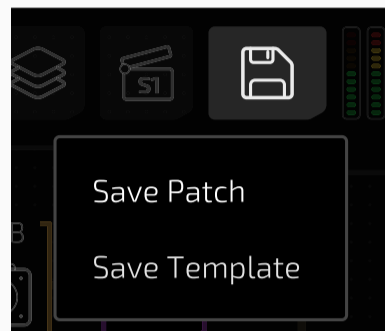

Then select Save Patch to enter Save Menu:

Annotations for the SAVE menu:

- Cancel saving and exit: 
- Select a patch location to save:   **A01-1**  
- Ampero II | 
- Changes the cursor position: 
- Deletes unwanted characters: 
- Space: 
- Lower/uppercase: 
- Numeric keyboard: 
- Confirm saving: 

Additional annotations:

-   : Change Patch
-   : Change Bank

In Patch Mode and Footswitch View, when you press  button, the unit will straightly go to Save Menu as shown above.

Patch Management

In Patch Mode and Footswitch View, press patch number to enter patch list. The patch list menu shows all patches on your Ampero II. You can browse through and jump to a patch directly, edit the patch list order, or copy/paste any patch.

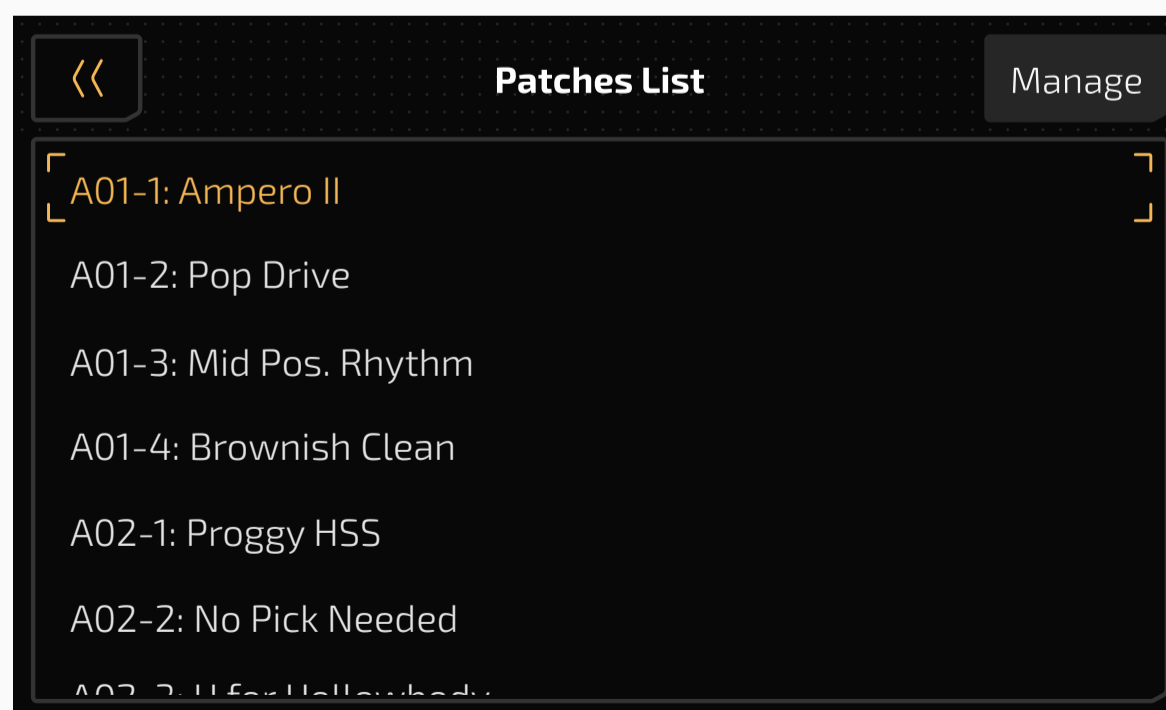

To select a patch, click on a patch name in the patch list.

Manage Patch Order

Select a patch, press Manage button and the management menu will appear:

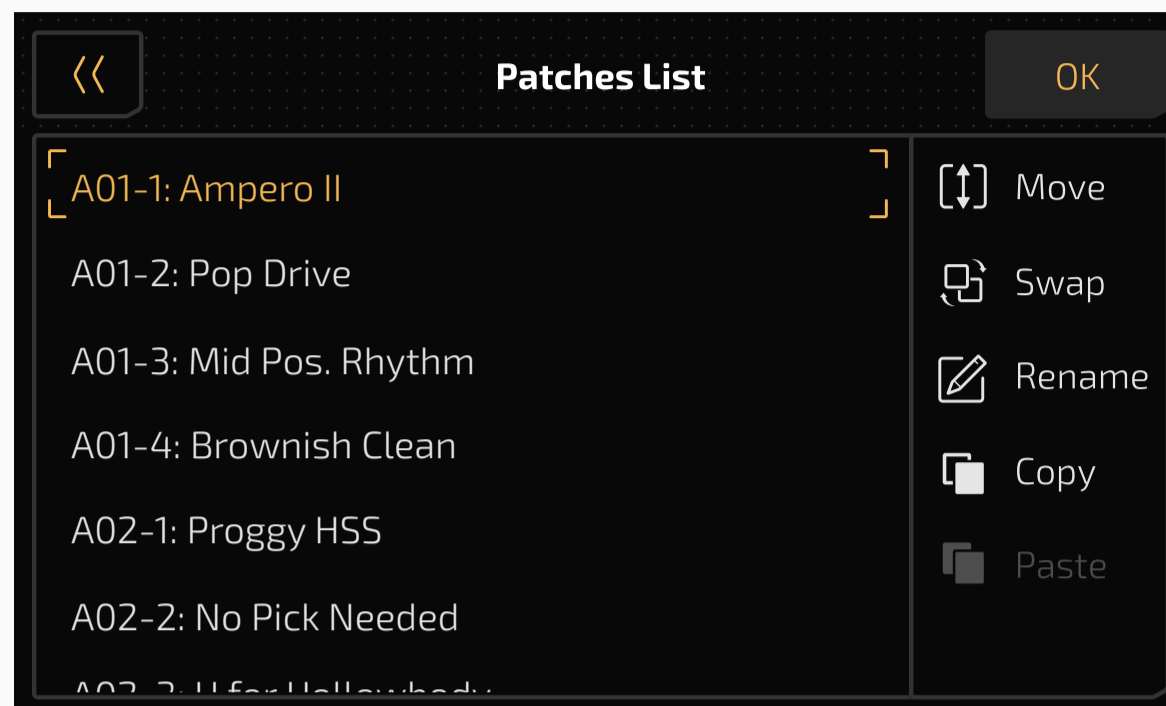

You can sort the list by moving or swapping.

Move

Press Move in the management menu, select a position, then the patch will be "inserted":

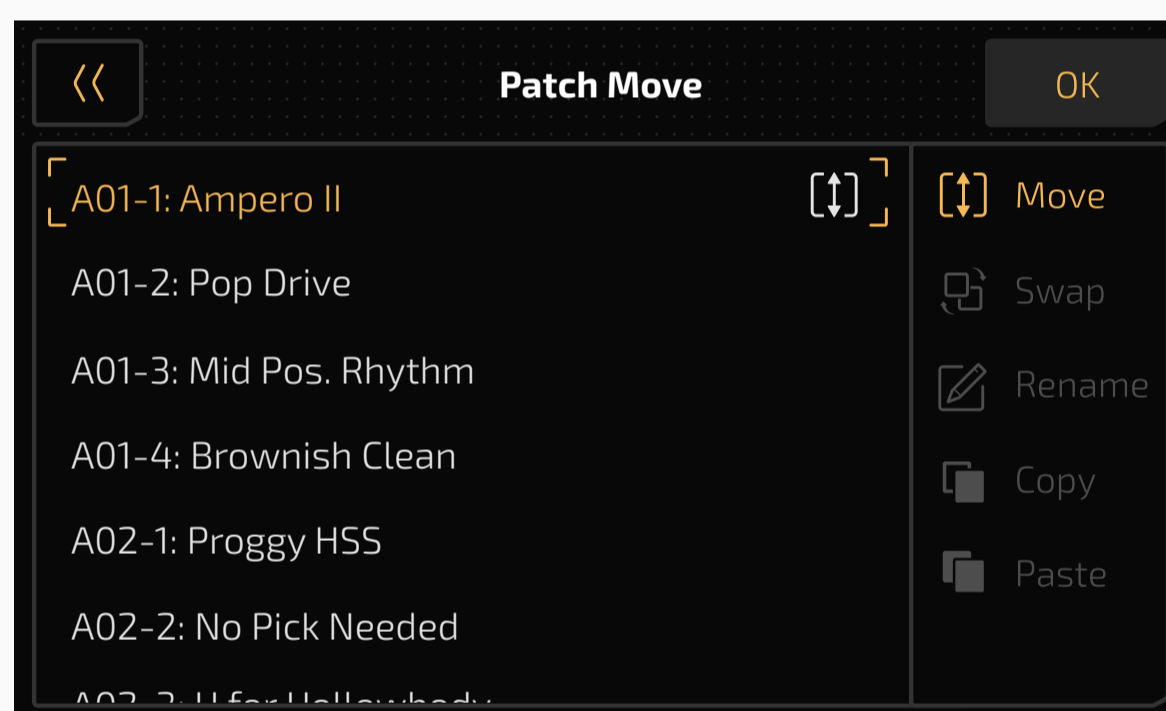

Swap

Press Swap in the management menu, and select a new position you need, then the two patches will be swapped:

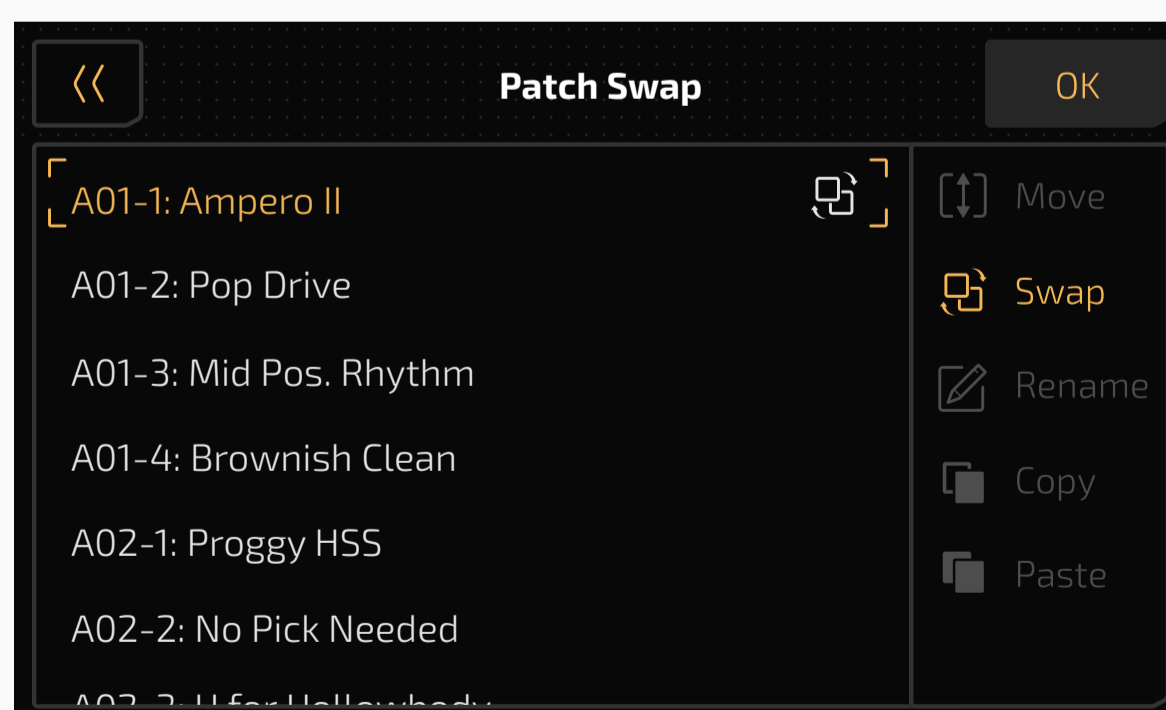

Rename

Select a patch, press Manage button, then press Rename in the management menu:



Enter a name and click OK to finish.

Copy And Paste

Select a patch, press Manage button, then press Copy in the management menu to copy a patch:

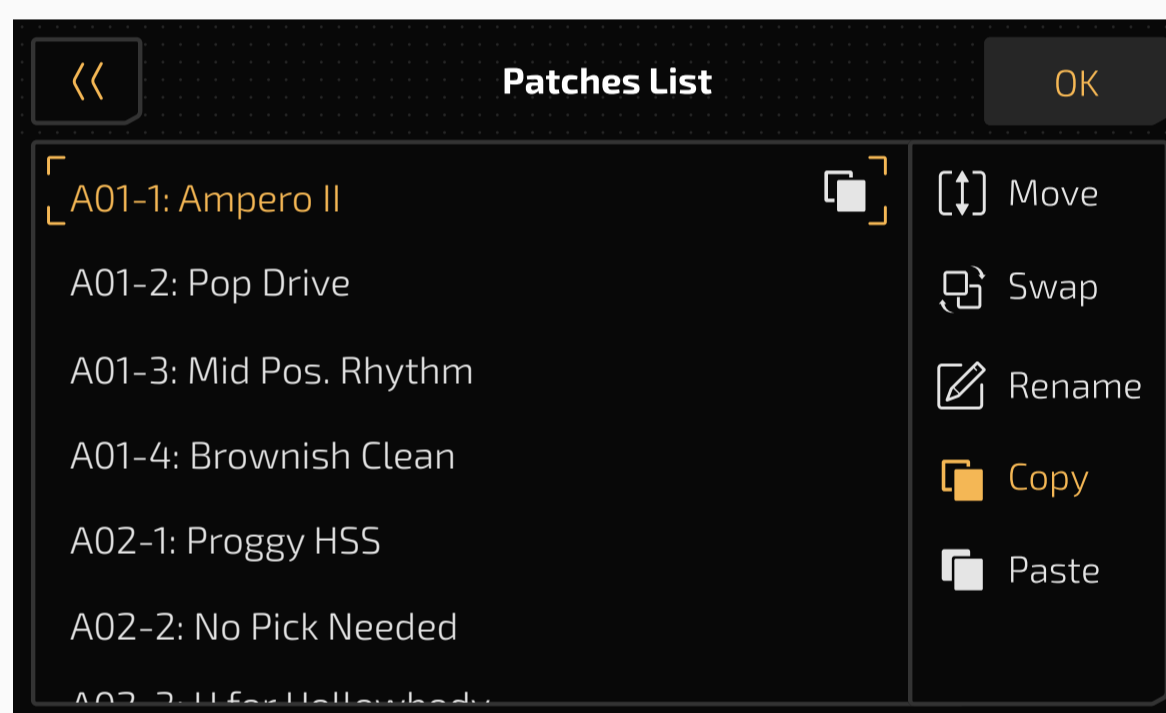

Then find a position you need and press Paste to paste the patch you copied.

1. You need to copy before paste.
2. The copied patch data will be lost when you move/swap patches, exit patch list or the unit power is off.
3. If there already exists a patch in the target position, pasting will overwrite existing data. A message will come up to notice:

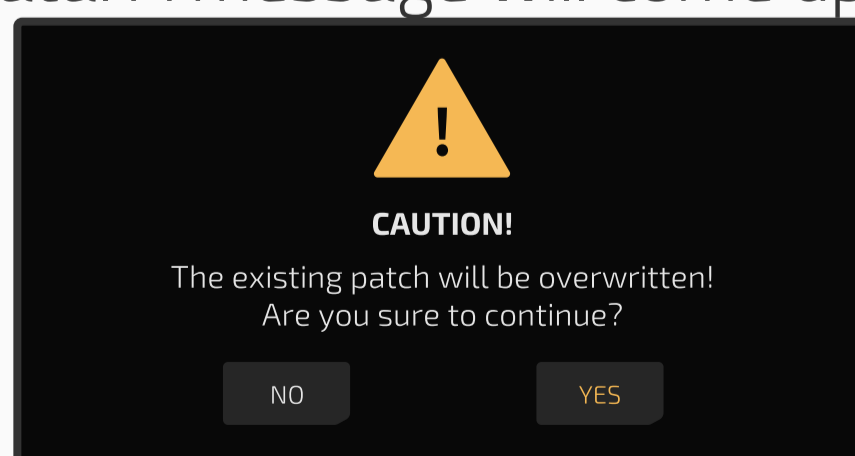

4. If you copied one other patch with an existing copy, the previous data will be overwritten.

» GLOBAL

Use the GLOBAL menu to set Ampero II's global functions like I/O, USB Audio, Global EQ and MIDI settings. You can also return to factory settings from this menu.

Global settings **will affect unit's overall working status**. These will override any other settings made to your patches. Any changes made in Global setting will be automatically saved and immediately operational.

In Patch Mode, press  to enter the global settings menu. The screen will look like this:

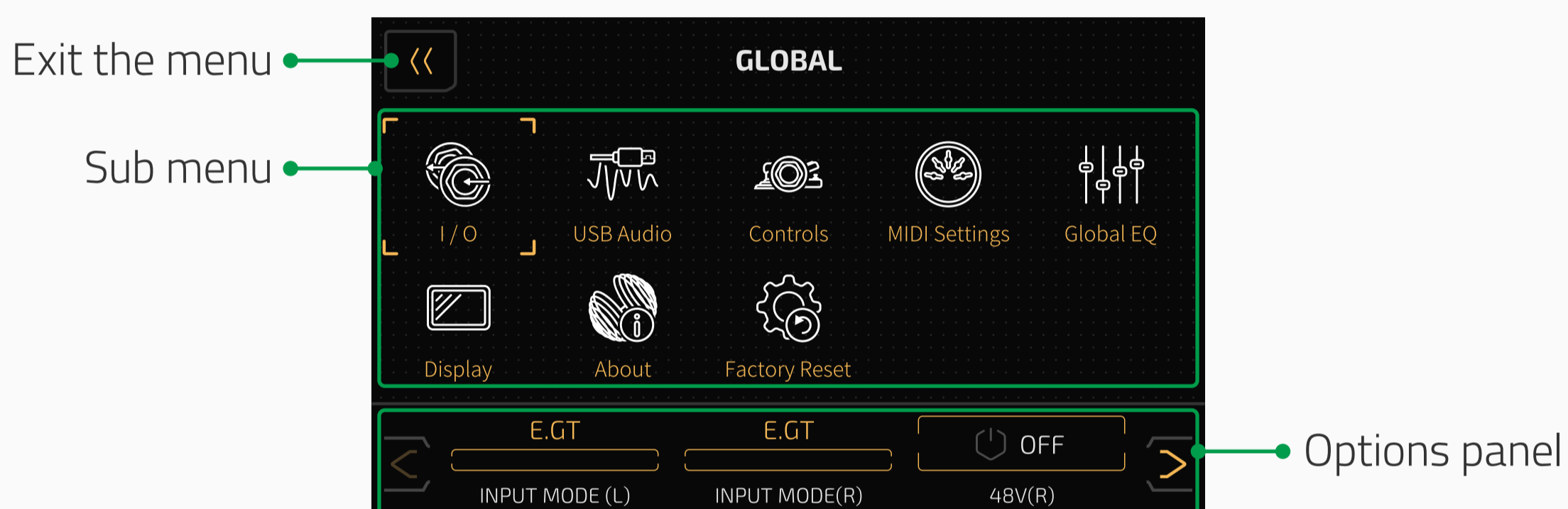

You can either use the touchscreen or turn the main knob to scroll through the menu targets. As you select your menu target, the selection panel will display the adjustable options of the target you select, which will vary according to the selection. If there are more than three options in the current selection, use the arrows to the right and left to scroll through the options.

I/O

Set the global input/output levels and modes in the I/O menu.

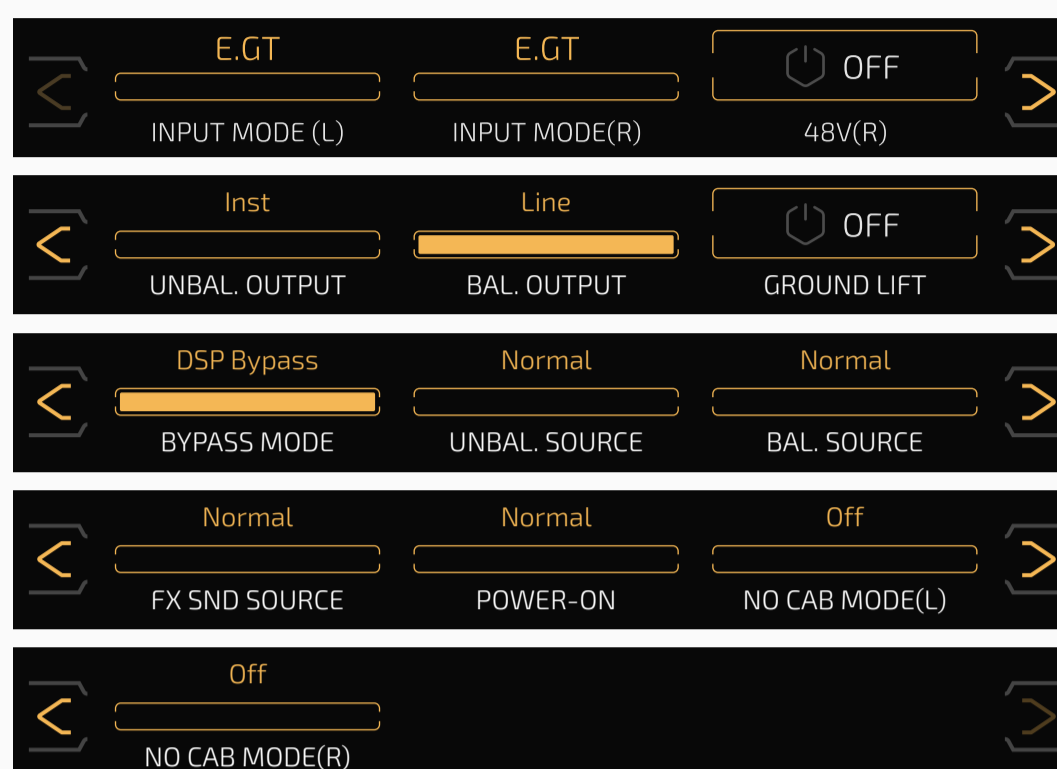
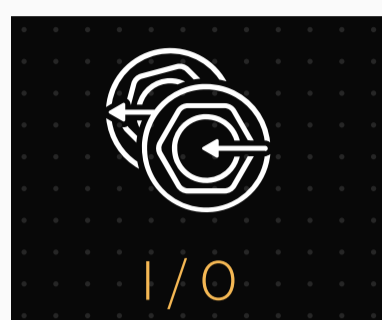

Use **INPUT MODE (L)/(R)** to select between input modes for individual input jack.

- E.GT: Electric guitar or bass
- A.GT: Acoustic guitar or other acoustic instruments
- Line: Keyboard or synthesizer

When a XLR cable is connected to Input R, the **INPUT MODE (R)** selections will go to:

- Line: Keyboard or synthesizer
- Mic: Microphones

Defaults are both set to E.GT.

Use **48V (R)** to switch phantom power on/off on Input R jack. This switch will be turned to off when powered up.

Use **UNBAL. / BAL. OUTPUT** to select between instrument output level (Inst) and line output level (Line) for both output jacks. Use the instrument level for connecting to amplifiers or other effects equipment. Use the line level for connecting to mixers or audio interfaces.

Default **UNBAL. OUTPUT** is set to Inst, and **BAL. OUTPUT** is set to Line. **BAL. OUTPUT** option won't affect phones output.

Use **GROUND LIFT** to cut off the ground connection of the two XLR

connectors (Ground Lift) to avoid noise caused by the Ground Loop. Turned Off, the XLR line will be ground normally. Default is set to Off.

Use **BYPASS MODE** to select between DSP Bypass and Analog Bypass modes.

Please remember **USB audio will also be bypassed when the unit is bypassed.**

- DSP Bypass

Default bypass mode featuring digital buffer bypass switching, great for avoiding signal loss that caused by long signal path (long patch cables, too many pedals in the chain, etc.). In most situation, DSP Bypass is recommended.

Supports mono in/mono out, mono in/stereo out, stereo in/out configurations. The XLR jacks and phones jack share the same output.

- Analog Bypass

Hardwire true analog bypass mode that keeps your signal path pristine. In this mode, the left input is directly connected to left output, so as the right I/Os. If you're facing impedance matching issues (e.g. use Ampero II before fuzz pedals), or want to keep a pure analog signal path, this mode is recommended.

Supports only mono in/mono out and stereo in/out configurations. **The phones output, XLR input/outputs and effect tail function will be disabled.**

Use **UNBAL. SOURCE**, **BAL. SOURCE** and **FX SND SOURCE** to select from different output signal source for outputs and FX loop send jacks:

- Normal: Both effect and USB audio output will be sent to the corresponding jack.
- USB Only: Only USB audio output will be sent to the corresponding jack. When Ampero II is your main USB audio interface, **if you need to monitor a track in a DAW while recording (or software monitoring), this selection is recommended.** If not, you'll hear both unit effect output and a slightly delayed DAW monitor output.

- Dry: Both dry signal and USB audio output will be sent to the corresponding jack.

Please note:

1. When using FX Loop Send jack as an output jack, the output signal may vary from patch settings, such as FX SND/FX LOOP module parameter settings and position on effects chains, output node settings, etc.
2. BAL. SOURCE option also affects phones output.

Use **POWER-ON** option to select a volume output mode when powered up:

- Normal: All output volume will be the same as your last settings
- Mute: All outputs will be muted

You can also mute all outputs by holding VOLUME knob while powering up.

NO CAB MODE is for connecting to instrument amplifiers without changing saved patches. Turning this on will bypass the CAB/IR module for Ampero II's L/R output channels ignoring patch settings. You can apply different settings on L/R output channels for different scenarios (unaffected by balanced/unbalanced output settings). Default is set to Off.

- Off: No cab mode off
- CAB Only: Only affects CAB module
- IR Only: Only affects IR module
- CAB+IR: Affects both CAB and IR modules

USB Audio

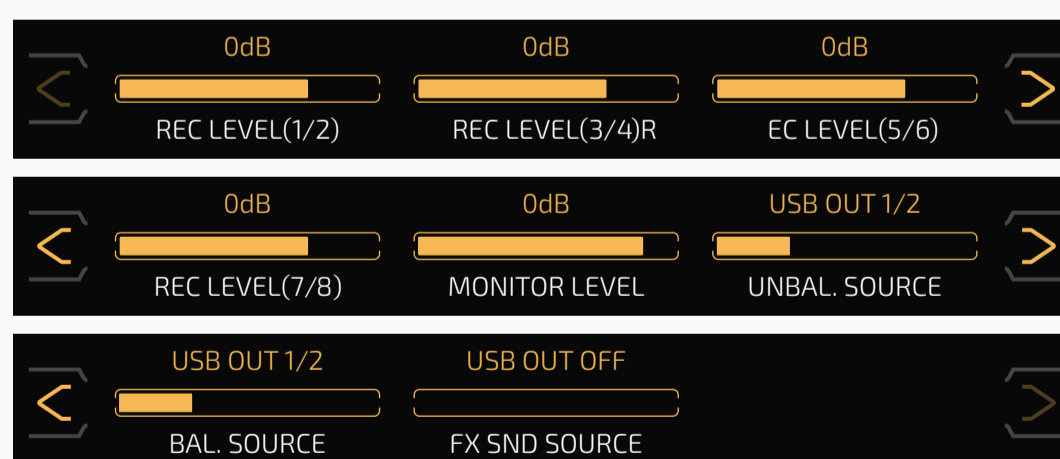
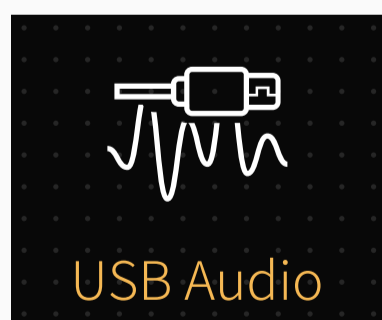

Use this menu to set up USB audio settings when using Ampero II as a USB audio interface.

Ampero II features an 8-in, 8-out USB audio interface with signal routings shown as below:

USB Audio Inputs Routing

Same rule as above: odd number stands for left channel and even number stands for right channel.

- Chain A outputs (after slot A6) and AUX Audio inputs are sent to USB Audio Input 1/2
- Chain B outputs (after slot B6) are sent to USB Audio Input 3/4; USB Audio Input 3/4 remains as long as the chain B is activated (not shown grey; regardless of chain B output node settings)
- When chain A and B are in series, USB Audio Input 1/2 and 3/4 are the same
- FX Loop Return inputs are directly sent to USB Audio Input 5/6 regardless of patch settings
- Input L/R signals (dry signal) are directly sent to USB Audio Input 7/8 regardless of patch settings

USB Audio Outputs Routing

- USB Audio Output 1/2 (the main output) are sent to output L/R and phones jacks
- USB Audio Output 3/4 to 7/8 are reserved for sending different USB outputs depending on your settings of your computer or DAWs

When recording, adjust the optimal **REC LEVEL** for each USB Audio Input 1/2 to 7/8 according to the instrument or other input you're using. Adjustable ranges are all from Mute~-60dB~+20dB, defaults are all set to 0dB.

Use **MONITOR LEVEL** to set a proper monitor level for overall USB audio outputs. Adjustable range is from Mute~-60dB~+6dB, defaults is set to 0dB.

Use **UNBAL. SOURCE**, **BAL. SOURCE** and **FX SND SOURCE** to determine which USB audio output will be sent to the corresponding jack. In default, the **UNBAL. /BAL SOURCE** is set to USB OUT 1/2, and **FX SND SOURCE** is set to USB OUT OFF.

Detailed Hardware and USB Audio Routing

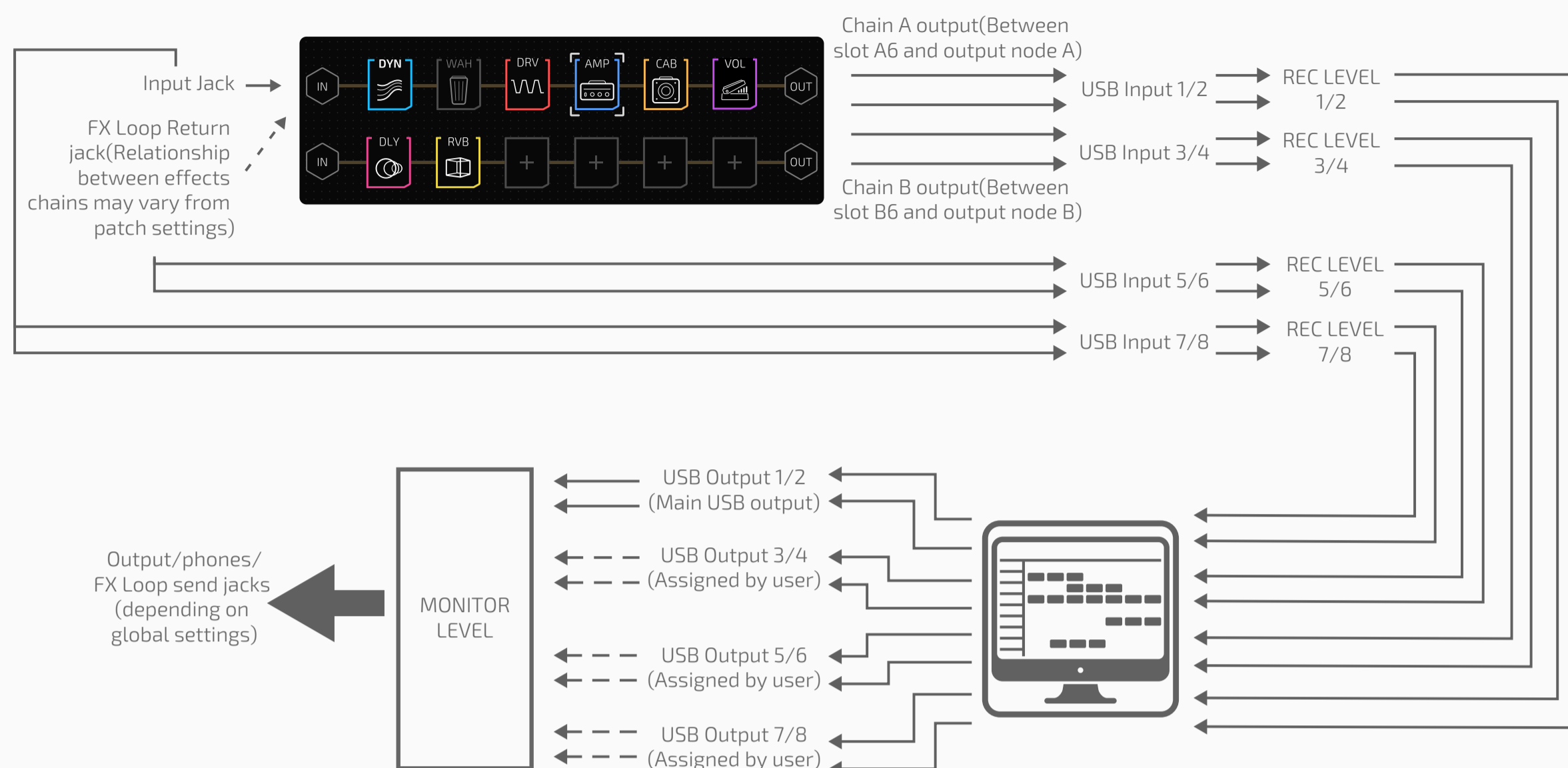

Advanced USB Audio Interface Function Guide

Next we'll show you some advanced tricks when using your Ampero II as a USB audio interface.

Example 1: Monitoring Different Outputs

You can use Ampero II's output/phones jacks and FX loop send jack for monitoring different signal sources.

In this example, a guitar is connected to unit's left input, and a bass is connected to the right input. The two instruments will be recorded simultaneously with different effects:

- (1) Connect a pair of headphones to phones jack, connect a pair of monitor amps to FX loop send jack via a Y cable (unbalanced connection);
- (2) Launch a DAW and create two mono audio tracks. Set track 1's input to USB Audio Input 1, output to USB Audio Output 1/2; set track 2's input to USB Audio Input 3, output to USB Audio Output 3/4. Then turn on monitor switches on both tracks;
- (3) On your Ampero II, enter USB Audio menu and set **OUTPUT SOURCE** to **USB OUT 1/2**, then set **FX SND SOURCE** to **USB OUT 3/4**;
- (4) Enter I/O menu, set both **OUTPUT SOURCE** and **FX SND SOURCE** to **USB Only**;

- (5) In the current patch, set the chain A/B to **parallel** and **use mono effects only** (e.g. amps and cabs);
- (6) Set chain A's input source to **Input L** and output to **output jacks**;
- (7) Set chain B's input source to **Input R** and output to **FX loop send jack**;
- (8) You'll hear guitar signal in headphones and bass signal in monitor amps if everything is set. Then record and get individual guitar and bass tracks.

Example 2: Record Dry/Wet Tracks Simultaneously or Record Dry, Monitor Wet

You can use Ampero II's multiple USB audio I/Os for recording multiple dry/wet tracks with DAW.

In this example, all global settings are set to default, factory patch A01-1 is loaded:

- (1) Connect a pair of headphones to phones jack and connect a guitar to unit's input L channel;
- (2) Launch a DAW and create two audio tracks. Set track 1's input to USB Audio Input 1/2, output to USB Audio Output 1/2; set track 2's input to USB Audio Input 7, output to USB Audio Output 1/2. Then keep monitor switches off on both tracks;
- (3) Still in DAW, set the two tracks can be recorded at the same time;
- (4) Record both tracks. Then you get a stereo guitar track with effects and a mono dry guitar track.

If no wet signal is needed, in step (2) you only need to create one audio track and set track input to USB Audio Input 7 (or 7/8 depending on your needs).

Example 3: Reamping or Tone Creation with Dry Tracks

You can route Ampero II's USB audio outputs to effects chains for reamping. In this example, all global settings are set to default, and several guitar/bass dry DI tracks are needed:

- (1) On your Ampero II, create a new patch and use chain A only. Set input node **Source** to **USB OUT 3/4**, **INPUT CH to L**, and keep other parameters as default;

- (2) Add an AMP and a CAB module in AMP-CAB order;
- (3) Launch a DAW and create two audio tracks. Set track 1's input to None, output to USB Audio Output 3/4; set track 2's input to USB Audio Input 1, output to USB Audio Output 1/2. Then keep monitor switches off on both tracks;
- (4) Still inside the DAW, set only track 2 can be recorded, and import a dry track (Audio Clip A) to track 1;
- (5) Connect a pair of headphones to phones jack or a pair of monitor amps to output L/R jacks (balanced connection);
- (6) Inside the DAW, start playback and loop the dry track in track 1, you'll hear the Audio Clip A with effects (depending on AMP and CAB settings);
- (7) Adjust AMP and CAB parameters;
- (8) Turn off looping switch inside the DAW. Record on track 2 with track 1 playing simultaneously. Then you get a wet track as you've heard in step (6) (7);
- (9) Repeat the steps above to get different reamped tracks.

For tone creation, you only need to execute steps (1) to (7).

Setting the USB Audio Sample Rate for the Ampero II

For Windows users: Please download and install latest HOTONE GENERIC USB ASIO DRIVER on your computer first. Once the Ampero II is connected to the computer, click  icon on the system tray (usually located in the lower right corner on the desktop) to open the driver software panel. You can use Sample Rate panel to configure the USB audio sample rate:

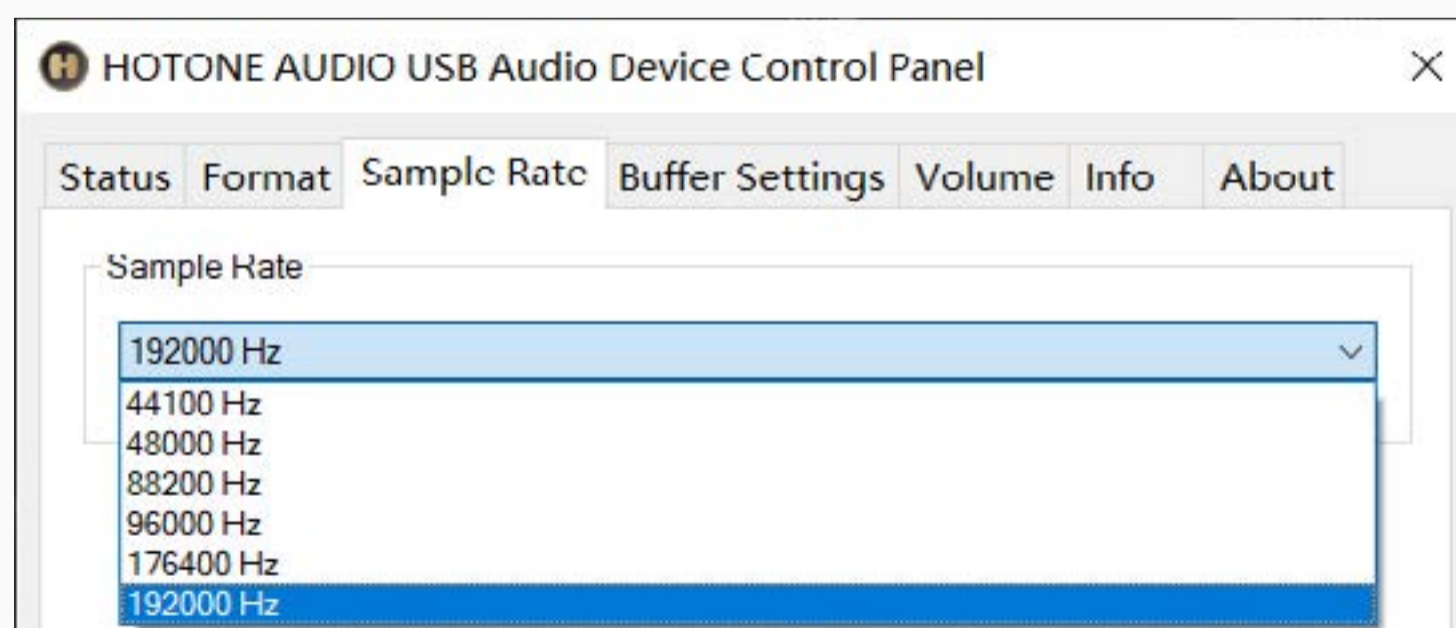

For Mac users: Directly connect Ampero II to your computer, open the "Audio MIDI Setup" application on your Mac, choose "Ampero II Audio", then use "Format" option to set the USB audio sample rate:

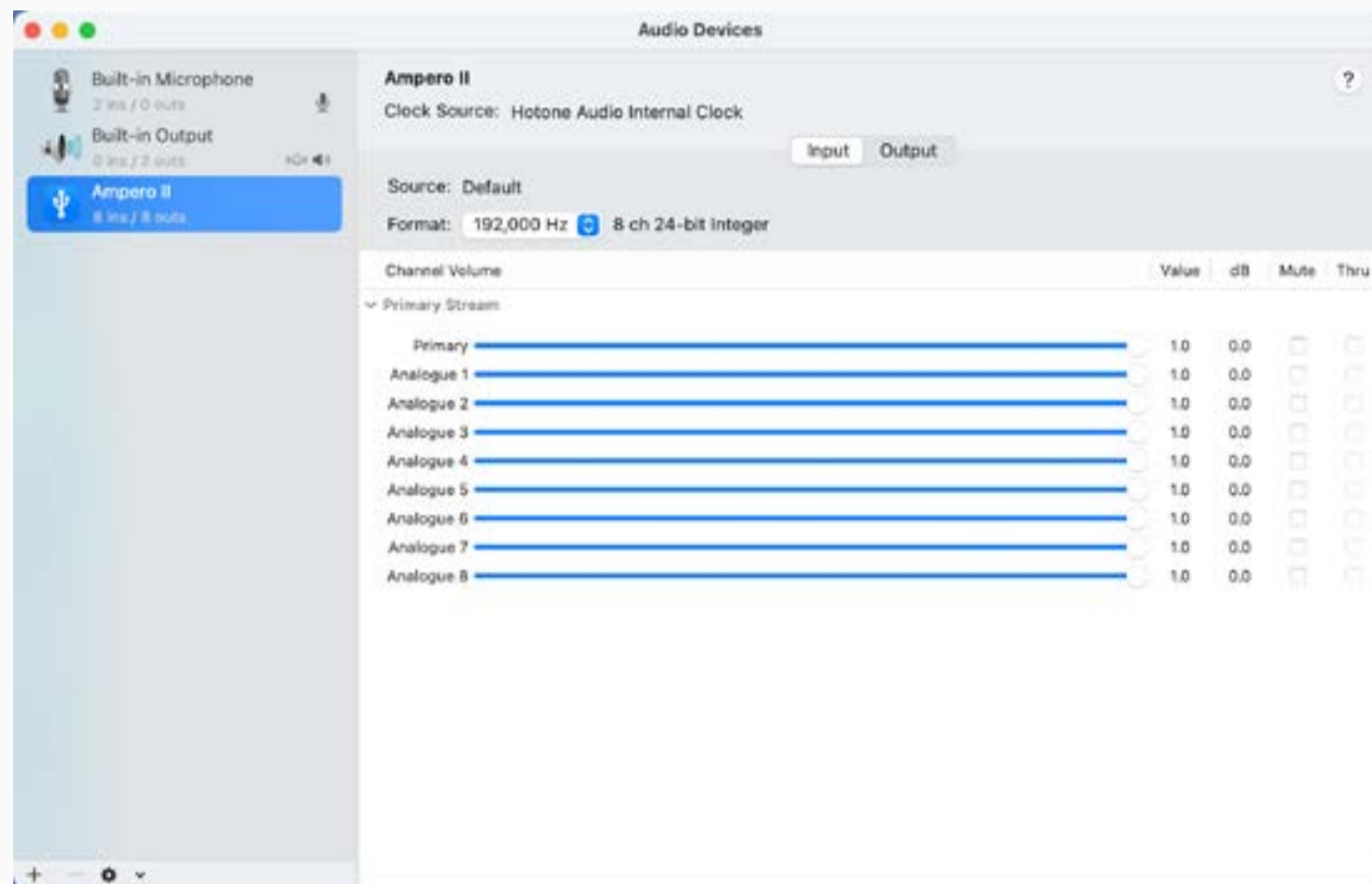

Controls

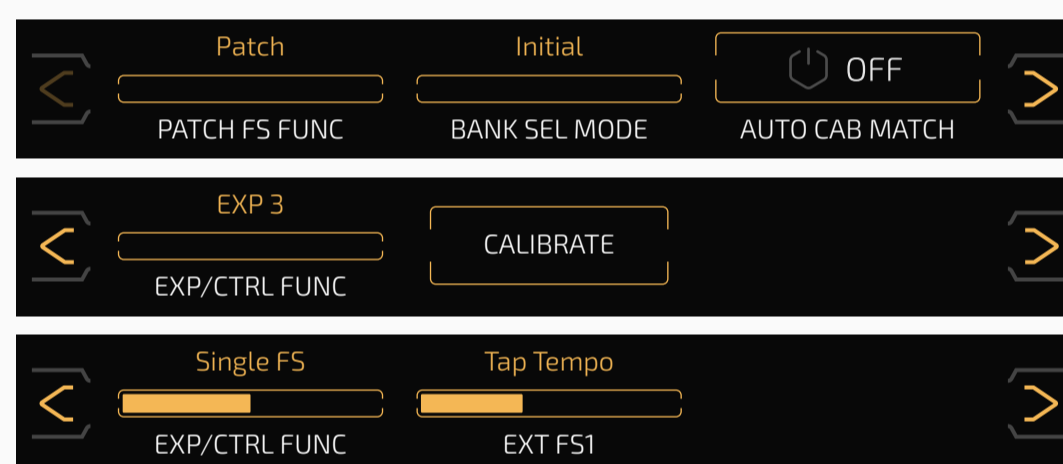
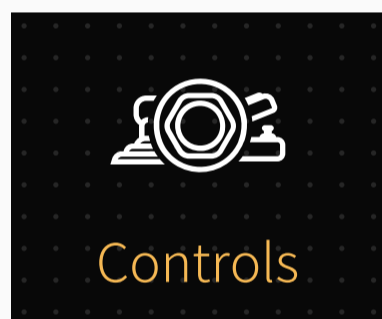

Use this Controls menu to set up patch footswitch function, bank select mode, automatic cab match and external controllers.

Use **PATCH FS FUNC** to select additional functions for pressing footswitch 1-4 in the Patch Mode.

- Patch: Press down the footswitch 1-4 to select between patch 1-4 in the current bank. Press the footswitch corresponding to the current patch again with no function.
- Patch/FX Slot 1: Press the footswitch corresponding to the current patch to switch the module on/off for this patch Effects Slot 1
- Patch/Scene 2: Press the footswitch corresponding to the current patch to switch to Scene 2 of this patch

- Patch/Bypass: Press the footswitch corresponding to the current patch to bypass the unit.

Use **BANK SEL MODE** to switch between two bank select modes in Patch Mode: Initial and Wait.

Default is set to Initial. This affects both built-in and external footswitches:

- Initial: Ampero II will jump to a new patch immediately after switching a bank.
- Wait: When switching banks, the unit will enter patch pre-select menu shown as below:

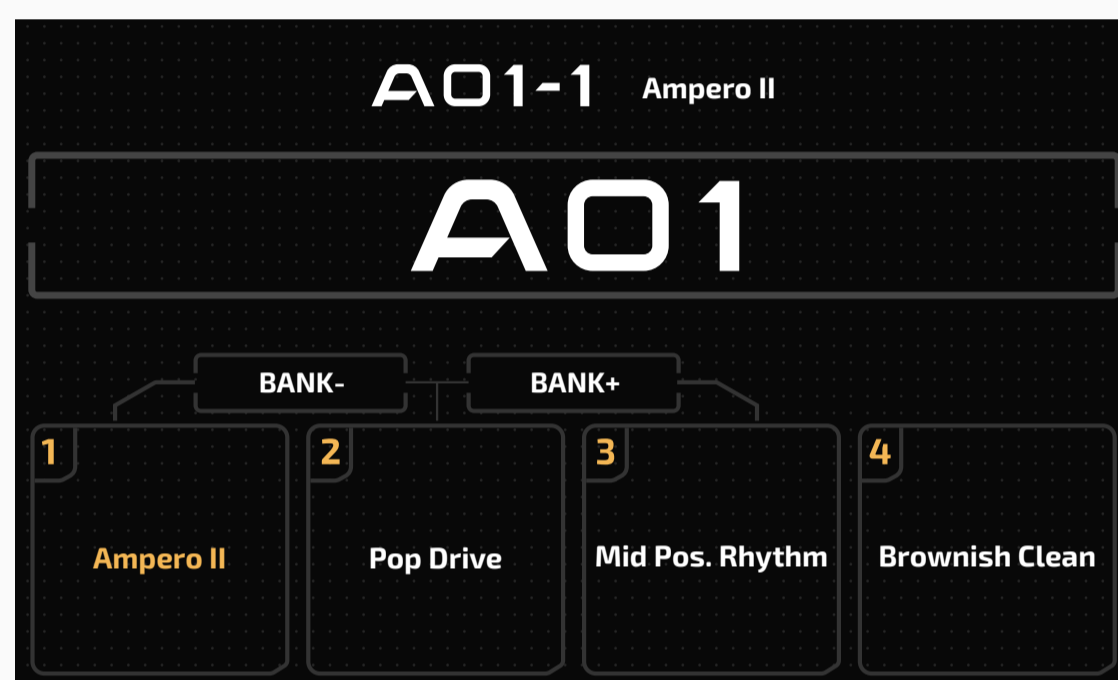

In this menu, the current patch you're using won't be changed (footswitch LEDs on Ampero II will keep flashing) until you tap a footswitch again to confirm your selection.

The **AUTO CAB MATCH** function will automatically help you match a cab when switching amps. Default is set to off:

- Great for patches with only one AMP and CAB module.
- The cab will automatically change according to the amp model you choose; matched cab list please check Effects List.

EXP/CTRL FUNC allows you to set up the working mode of EXP/CTRL jack and the functions of external footswitches. Available selections are:

- EXP/CTRL FUNC: EXP 3, Single FS (single footswitch controller) and Dual FS (dual footswitch controller)
 - When set to EXP 3, a CALIBRATE option appears for calibrating external expression pedal

- When set to Single FS, an extra **EXT FS1** option appears for selecting external footswitch function
- When set to Dual FS, extra **EXT FS1** and **EXT FS2** options appear for selecting external footswitch functions

EXP/CTRL FUNC is defaulted to EXP 3.

EXT FS1/2 can be set up as follows:

- Loop Rec/Play: Record/play loop phrases
- Loop Stop: Stops looper playback
- Loop Undo/Redo: Executes undo/redo function
- Loop 1/2 SPD: Switches 1/2 speed record/playback on/off
- Looper Rev: Switches reverse record/playback on/off
- Looper: Enter looper menu
- Looper Exit: Exit looper menu
- Tuner: Enter/exit tuner
- Drum: Enter/exit drum menu
- Drum Play/Stop: Start/stop drum playback
- Bank+/Bank-: Change banks by toggling up or down
- Tap Tempo: Tap tempo function
- Patch+/Patch-: Change patches by toggling up or down
- Scene 1-4: Switches to scene 1-4 in current patch
- EXP 1/2: Toggle between EXP 1/2
- Unit Mode: Toggle between Patch/Stomp Mode
- Bypass: Bypass the unit
- A1-B6 On/Off: Switching corresponding slot on/off

Plus:

When set **EXP/CTRL FUNC** to **Single FS**, the **EXT FS1** defaults to **Tap Tempo**;

When set **EXP/CTRL FUNC** to **Dual FS**, the **EXT FS1** defaults to **Bank-** and **EXT FS2** defaults to **Bank+**.

GLOBAL TEMPO can replace all patch tempo with a single global tempo. When GLOBAL TEMPO is enabled, the tempo icon in main display will be displayed in the system theme color:

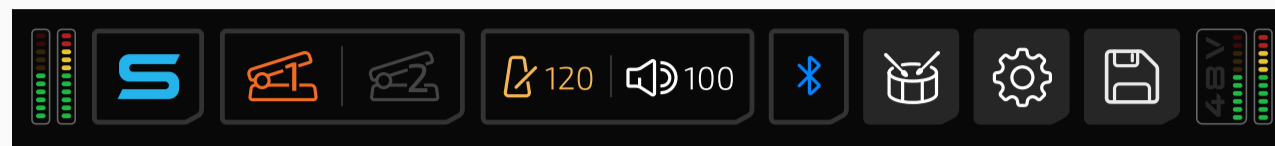

At this time, clicking the icon to adjust parameters or using the tap tempo function will directly change the global tempo. When the DRUM SYNC and the Sync switches for effects in modules like MOD, DLY, FREQ, etc. are turned on, the drum BPM or effect time/rate will synchronize with the global tempo. Global tempo remains unchanged when switching patches, and is automatically saved upon shutdown.

MIDI Settings

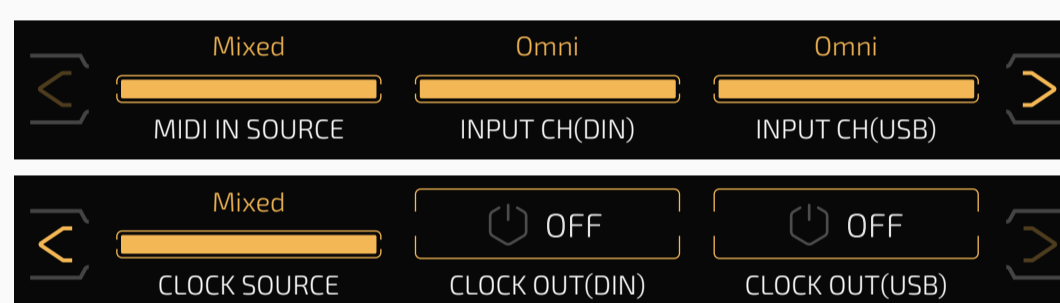
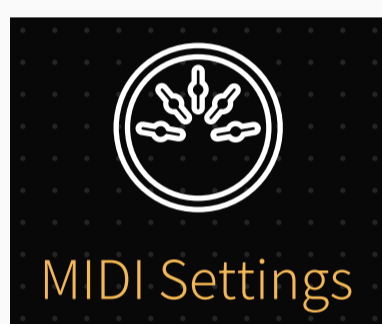

This menu allows you to set up Ampero II's MIDI input source, MIDI input channels, MIDI clock I/O options.

MIDI IN SOURCE allows you to choose a MIDI input source:

- DIN Only: Receives MIDI messages from MIDI IN jack only
- USB Only: Receives MIDI messages from USB jack only
- Mixed: Receives MIDI messages from MIDI IN jack, and USB jack

Default is set to **Mixed**.

INPUT CH (DIN/USB) options are for setting MIDI input channels of USB/MIDI jacks. The ranges are all 1-16-Omni, defaults are all Omni.

CLOCK SOURCE lets you choose MIDI clock source for syncing with other devices:

- Internal: Use internal clock only
- DIN Only: Uses only external clock, receives MIDI clock messages from MIDI IN jack

- **USB Only:** Uses only external clock, receives MIDI clock messages from USB jack
- **External:** Uses only external clock, receives MIDI clock messages from both MIDI IN/USB jack
- **Mixed:** Uses both internal/external clock sources (receives MIDI clock messages from both MIDI IN and USB jacks); later clock messages will replace previous messages

Default is set to **Mixed**. If you set clock source to DIN Only or USB only, Ampero II's Tap Tempo will not function.

CLOCK OUT (DIN/USB) switches MIDI clock output on/off. Turn on to use Ampero II as your main MIDI clock. If you're using clock out, the external clock input will be ignored; if you set **CLOCK SOURCE** to **DIN/USB Only**, there will be **no** MIDI clock output. Defaults are all set to Off.

Global EQ

This menu allows you to setup Ampero II's global EQ for overall tone sculpting:

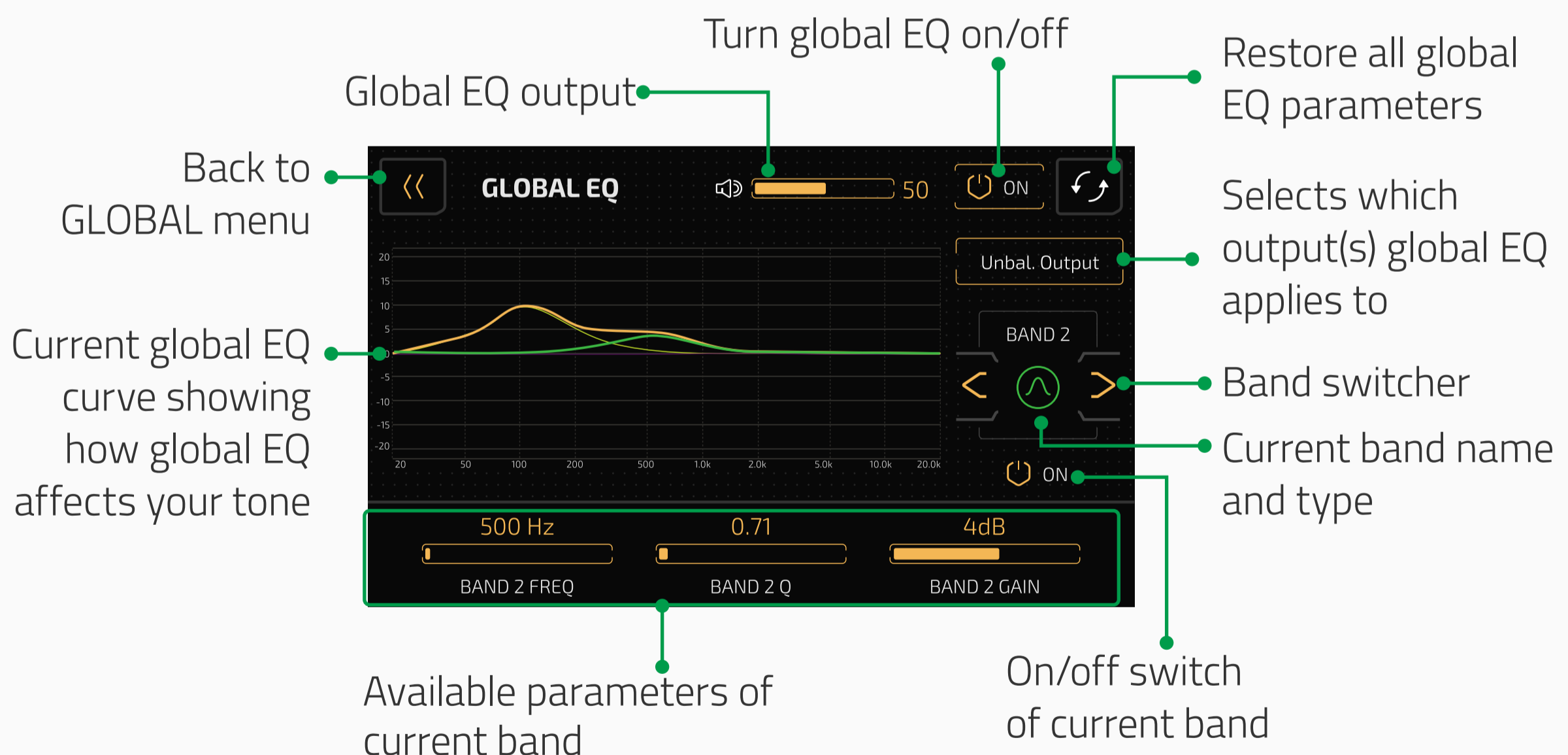

This is a 4-band parametric EQ with low/high cut and low/high shelf filters with individual band on/off switches:

- **LOW CUT:** High pass filter that attenuates low frequency contents under

the frequency you set; available parameters are FREQ and Q

- LOW SHELF: Low shelf filter that boosts/cuts low frequency contents under the frequency you set; available parameters are FREQ, Q and GAIN
- BAND 1-4: Peak filters that boosts/cuts a certain frequency range; available parameters are FREQ, Q and GAIN
- HIGH SHELF: High shelf filter that boosts/cuts high frequency contents above the frequency you set; available parameters are FREQ, Q and GAIN
- HIGH CUT: Low pass filter that attenuates high frequency contents above the frequency you set; available parameters are FREQ and Q

Detailed parameter descriptions:

- FREQ: Controls the filter center frequency/cutoff frequency ranging from 20Hz to 20000Hz. The default FREQ settings of each band are:
 - LOW CUT and LOW SHELF: 20Hz
 - BAND 1: 100Hz
 - BAND 2: 500Hz
 - BAND 3: 1600Hz
 - BAND 4: 5000Hz
 - HIGH CUT and HIGH SHELF: 20000Hz
- Q: Controls the filter Q (width/sharpness or smoothness for low/high cut filters) from 0.10 to 10.00. Defaults are all 0.71.
- GAIN: Controls filter gain from -20dB to +20dB. Defaults are all 0dB.
- Volume: Sets the global EQ output from 0 to 100. Default is 50.

Reminder:

Please carefully set global EQ parameters for protecting your devices and ears

USB Audio will **NOT** be affected by global EQ

If a band doesn't work, please check whether the band is on or not

Reset button will reset **ALL** global EQ parameters

If you're using patches/effects (like reverbs) need a lot of DSP power, in this case, turning on global EQ (especially applying to all outputs) may cause system overload

Display

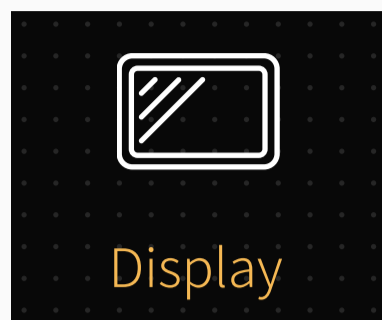

This menu setup display modes and system UI language.

Use **DISPLAY MODE** to switch between two display modes:

- Mode 1: The default display mode which stresses patch number:



- Mode 2: Stresses patch name:



Use **STOMP MODE** to switch between Footswitch/FX Chain views in Stomp Mode.

Use **LANGUAGE** to switch system UI language.

Use **COLOR** to choose from 7 system UI colors.

DISPLAY TIME lets you set how long screen display lasts for energy saving.

Selections are Always On, 1min, 5min, 10min, 20min, 30min, 40min, 50min, 60min. Default is 30min. When screen display goes out, any operation (e.g. touch the screen, plug in cables, press any footswitch) will wake up the screen.

BRIGHTNESS lets you set screen brightness from 0 to 100. Default is set to 50.

About

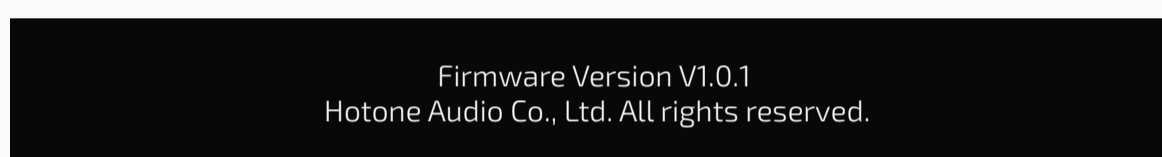
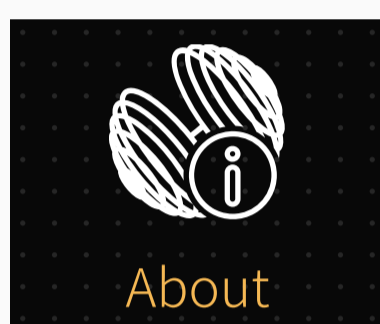

About will show you information about Ampero II's firmware.

Factory Reset



Use this menu to perform a factory reset.

- **Reset global:** Reset all global settings to factory default. Patches are not affected.
- **Reset patches:** Reset patch A01-1 to A31-4 to factory settings. Other data will not be affected.
- **Reset all data:** Performs a factory reset which deletes all user data and resets all settings.

Choose a selection depending on your needs.

Remember, resetting Ampero II will delete part/all of your saved changes and personal settings. Once it is executed, it cannot be undone, so please back up your settings before performing a factory reset.

After pressing Factory Reset, this display will come up with a warning.

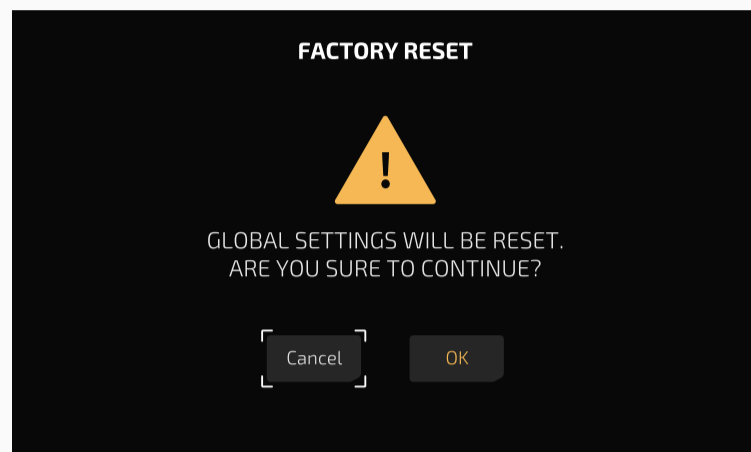

Choosing Reset global



Choosing Reset patches

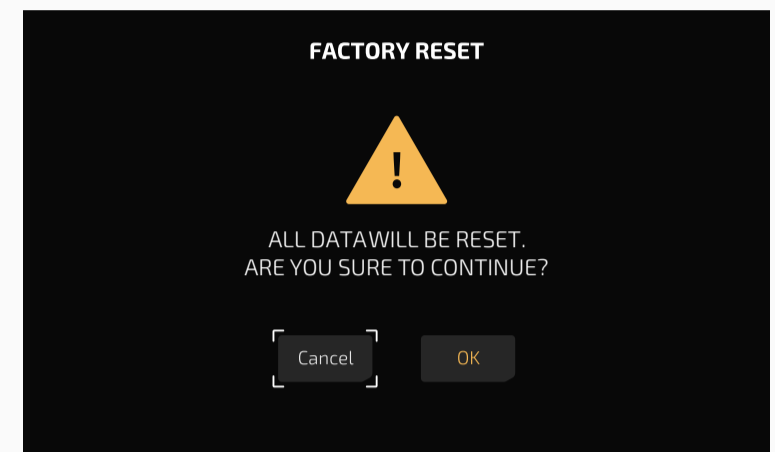

Choosing Reset all

Pressing OK will perform the factory reset. Pressing Cancel will return to the previous menu. After continuing with the factory preset, this screen will appear showing that reset is in progress. Do not disconnect the power supply while the reset is in progress. Disconnecting the power supply may cause Ampero II to malfunction.

When the factory reset is complete, this message will appear. Press OK to return to the main menu.

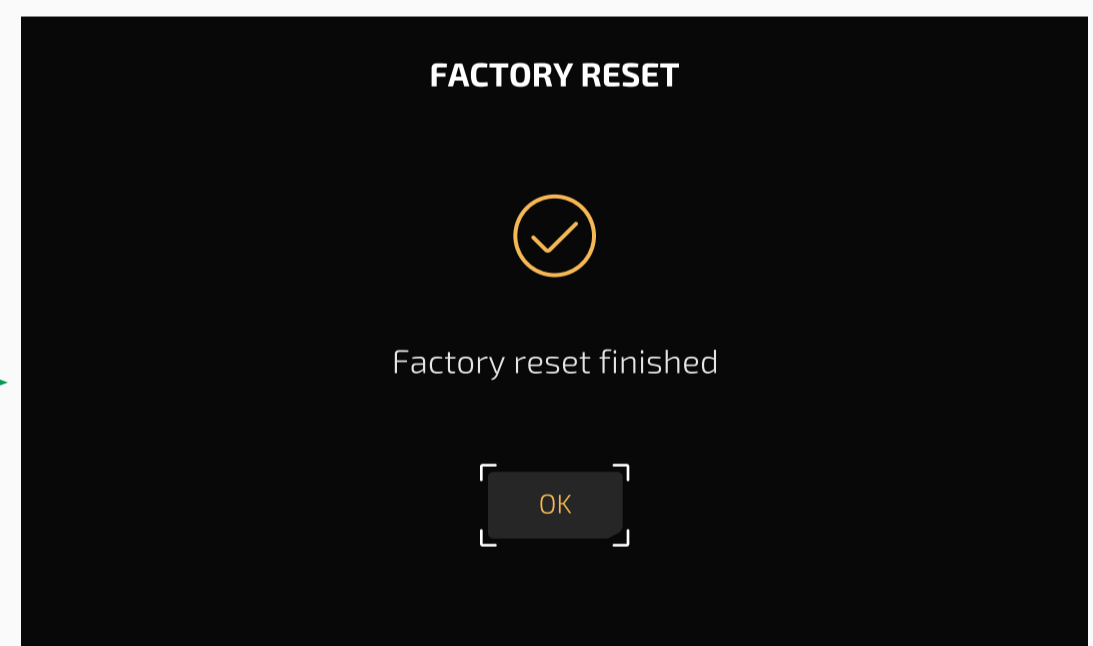
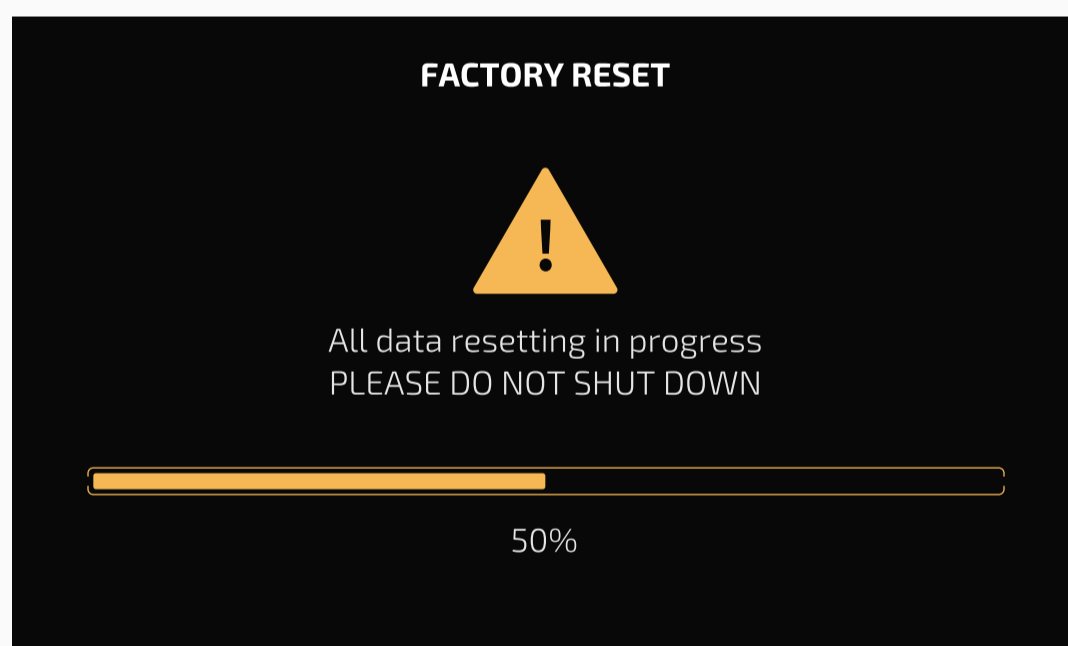

» Suggested Setups

Here are some common setups to get the most out of Ampero II.

Using with your instrument and amp

Plug your instrument into the unit's input L jack (or L+R if stereo connection is needed), and run a cable (or two) from the output jack(s) to your amplifier(s). If you have one amp, run the cable from the left output.

For best results, we recommend not to use AMP and CAB modules. You can add a PRE AMP module if you need more tonal flexibilities.

When using with FX Loop jacks, please remember to add FX Loop related modules (FX SND/RTN/LOOP) or setup input/output nodes properly.

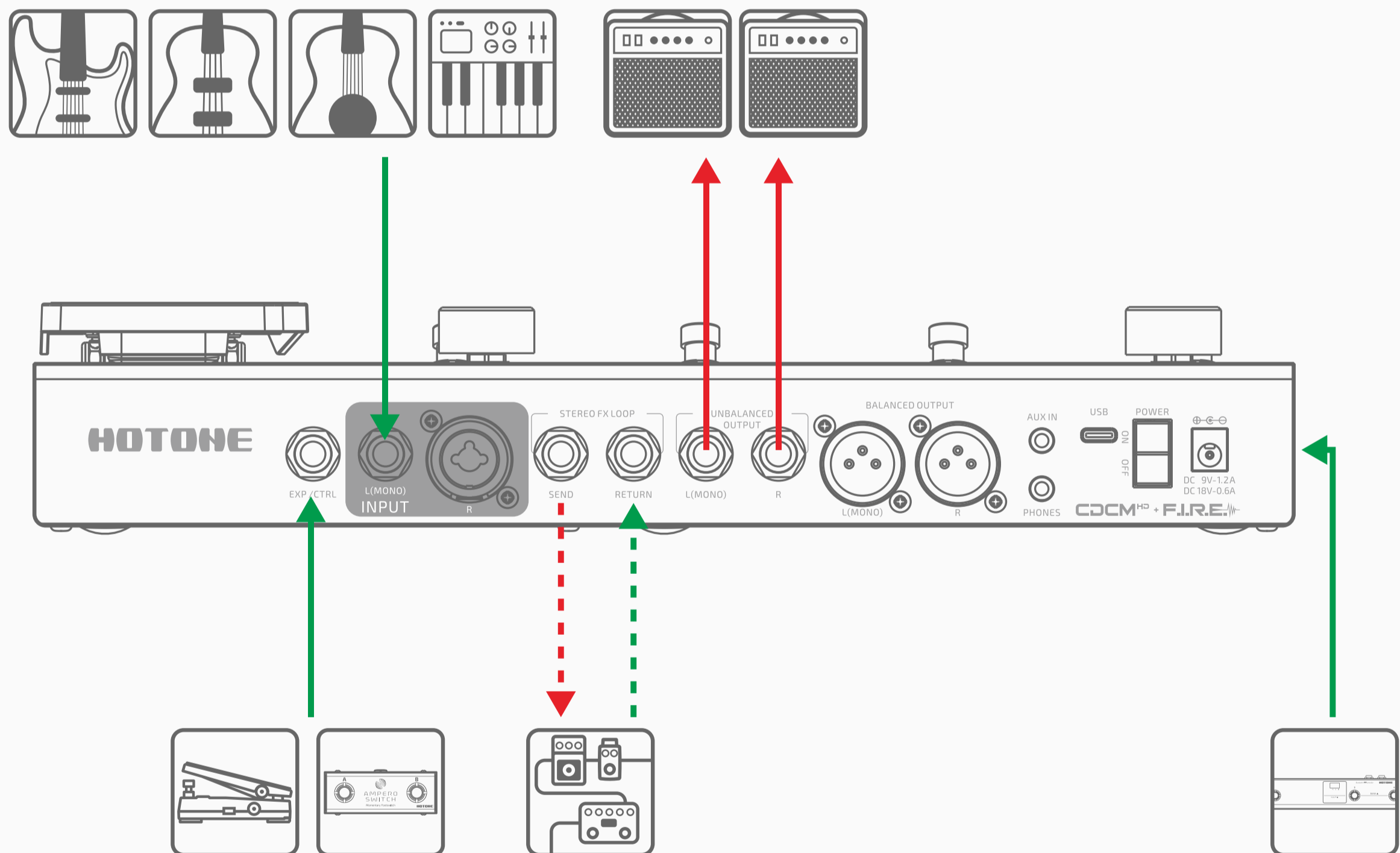

Connecting to your amp's RETURN or Power Amp (Loudster)/FRFR cabinet INPUT

Connect the outputs to your amp's FX Loop Return input or power amp input. If you have one amp, run the cable from the left output.

When using with non-FRFR amps, for best results, turn off the CAB module on Ampero II.

Sometimes, the AMP module may sound harsh or boomy when running through FX Loop Return jack on some amps. In this case, use PRE AMP module instead of AMP module.

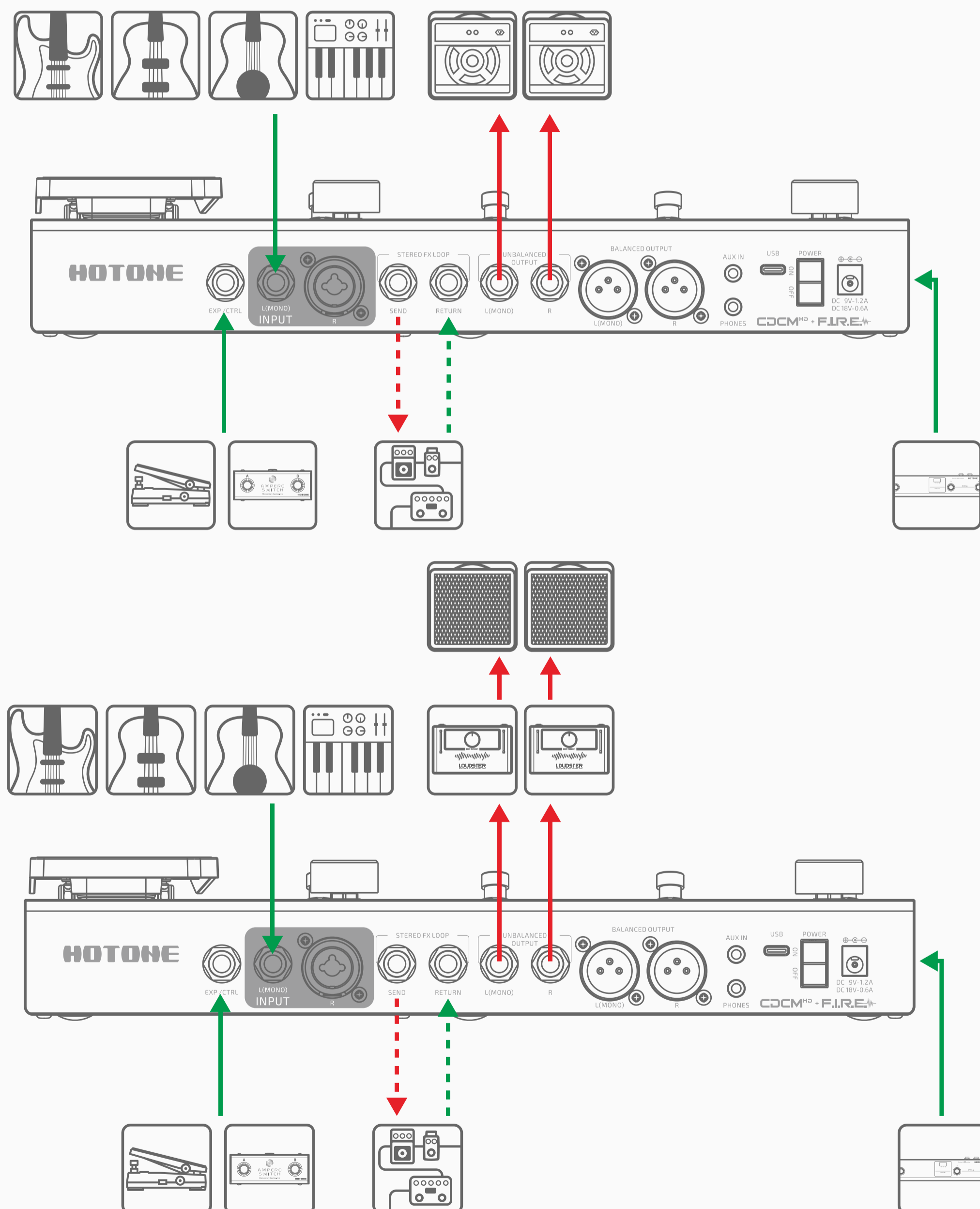

On-stage dual outputs

In this scenario, we recommend to use Y-A/B chain template:

- Chain A: Normal output with cab sim, send directly to mixer via XLR outputs;
- Chain B: Without cab sim, send to stage instrument amps via unbalanced outputs for monitoring

In this case, you can also pick up instrument amplifiers and mix them with Chain A outputs on mixer.

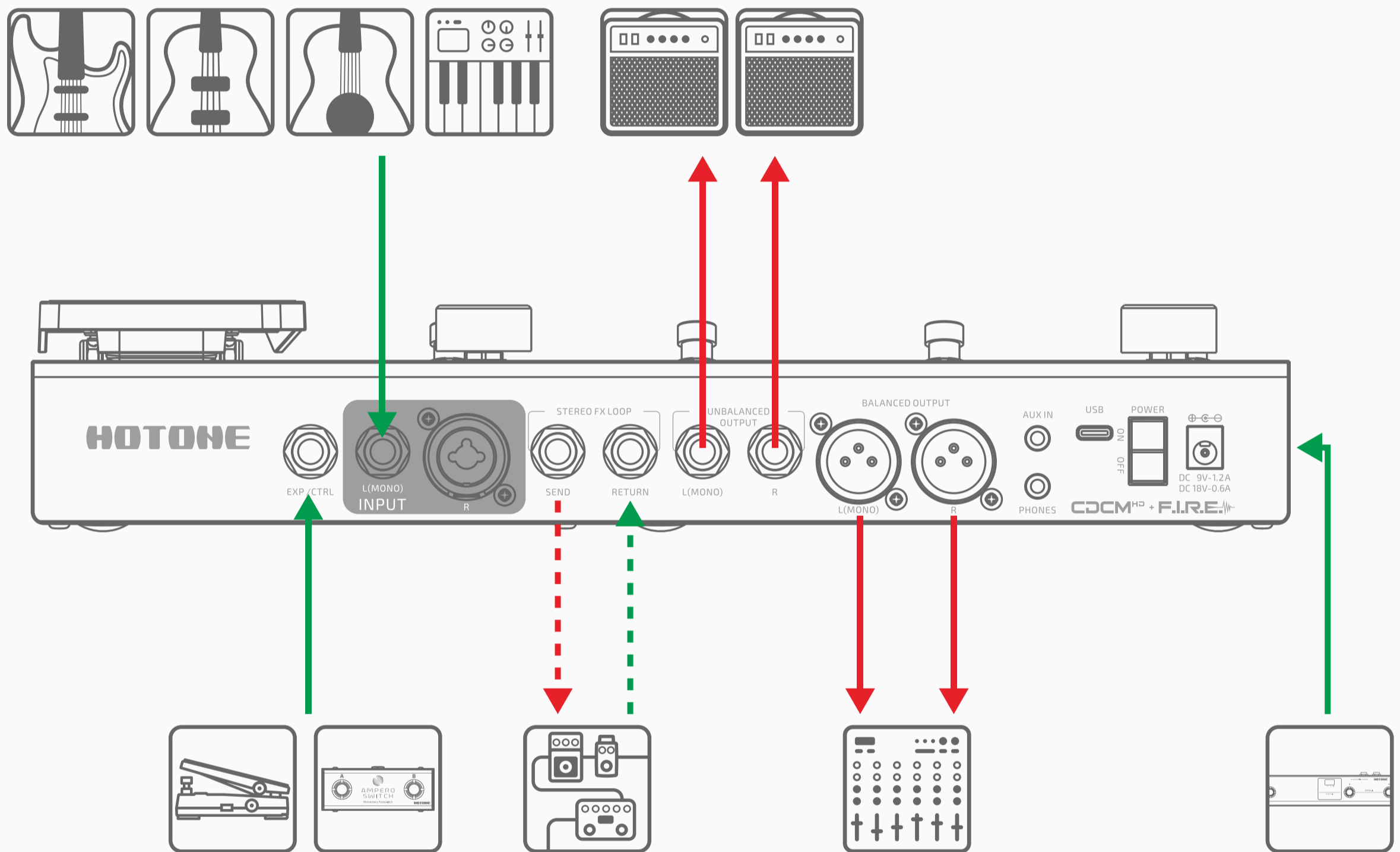

Singer performing with instruments

In this scenario, we recommend to use independent effects chains:

- Chain A: Processes instrument signal only and send to instrument amps via unbalanced outputs (or mixer/PA depending on your needs)
- Chain B: Processes vocal signal and send to mixer/full range speakers via XLR outputs

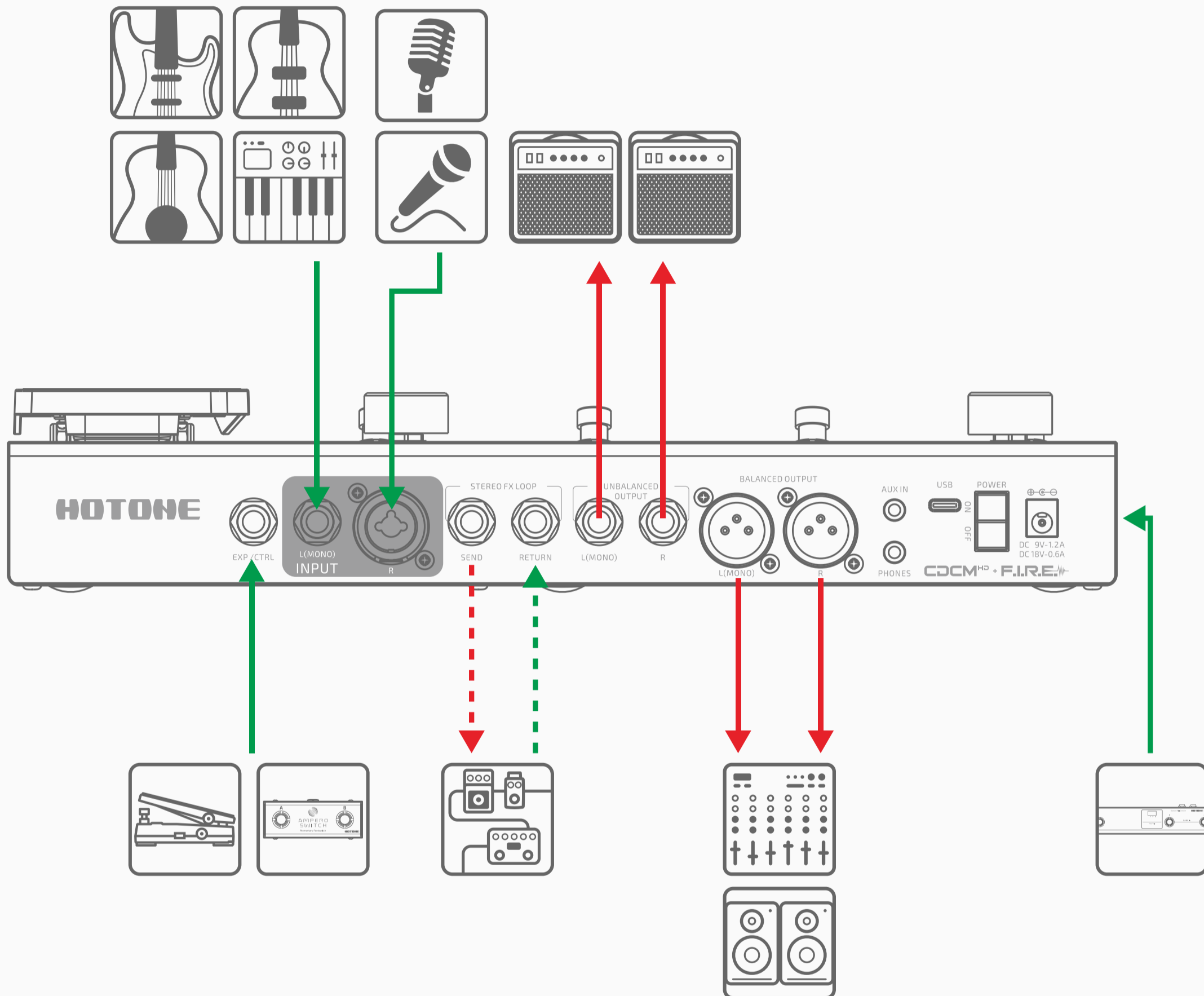

Connecting your mixer, interface, headphones, and other equipment

Connect Ampero II's outputs to your mixer or audio interface's corresponding inputs. We recommend you use balanced connection for optimal signal to noise ratio. If you want to send a mono signal out, use Ampero II's left output channel. To prevent damage to your equipment, make sure the mixer or interface channel's volume is muted before making any connections. Turn the output volume all the way down before connecting headphones to prevent harm to your ears. Ampero II's headphones out comes with hi-fi stereo sound.

For best results, please use AMP/PRE AMP and CAB modules.

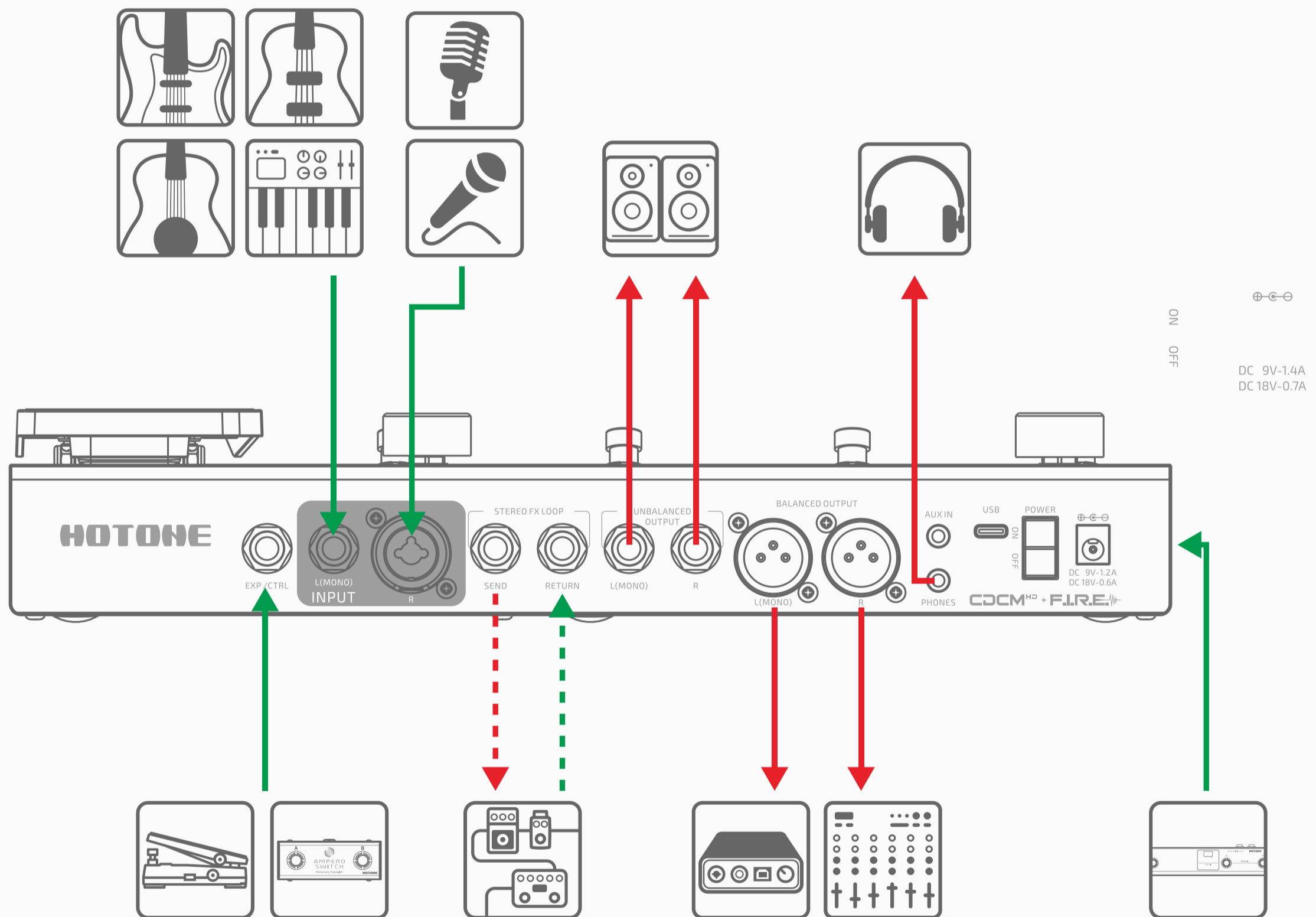

Connecting to your computer as an audio interface

Connect a USB cable from Ampero II to your computer. For PC systems, you'll need to set up the driver. Ampero II is plug and play for macOS. Run line out cables to your monitors, or use headphones.

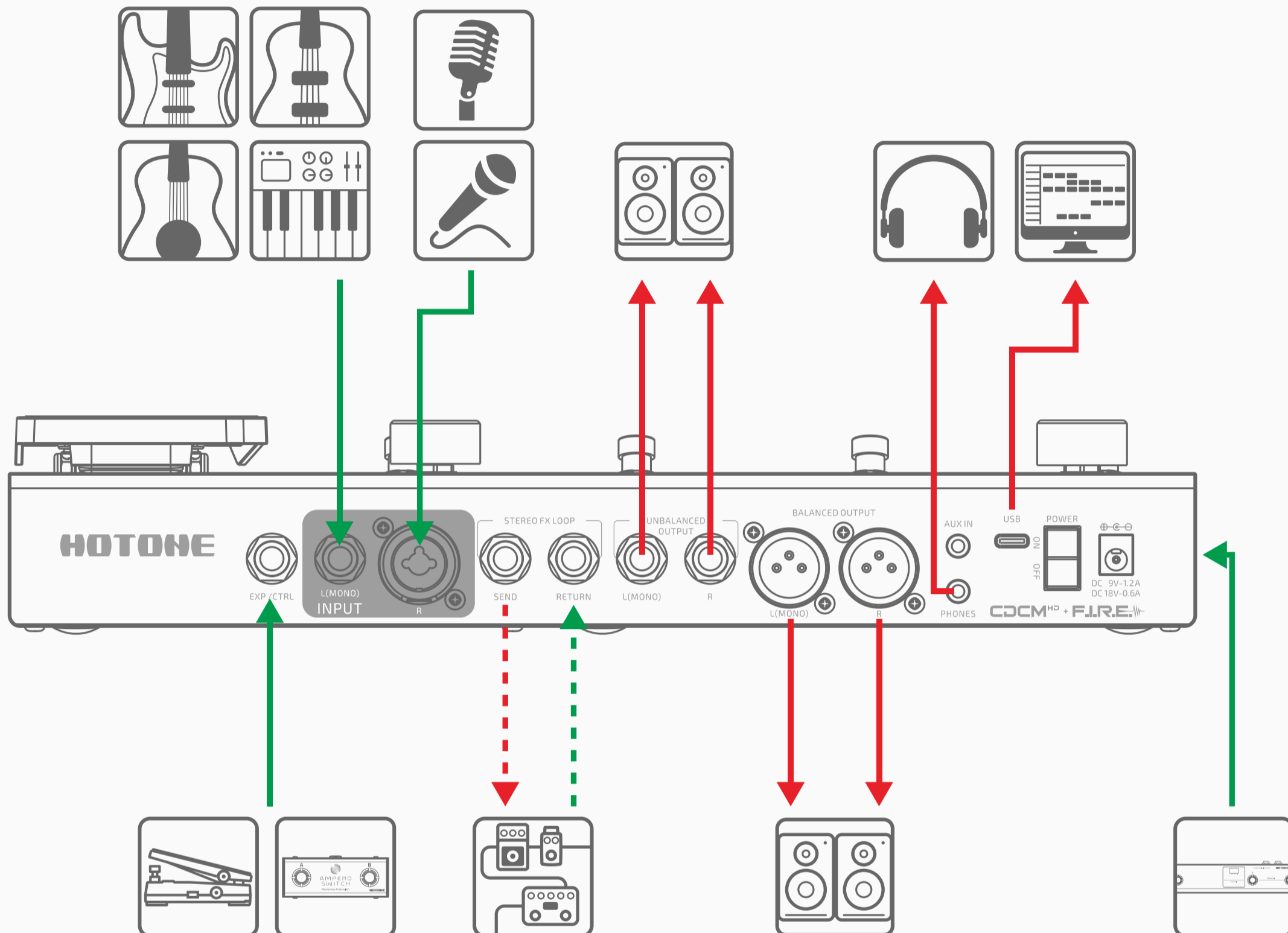

Using AUX IN

Find an aux cable and connect to Ampero II with your music player. Then you can practice and improvise as much as you want with backing tracks or built-in drum/looper.

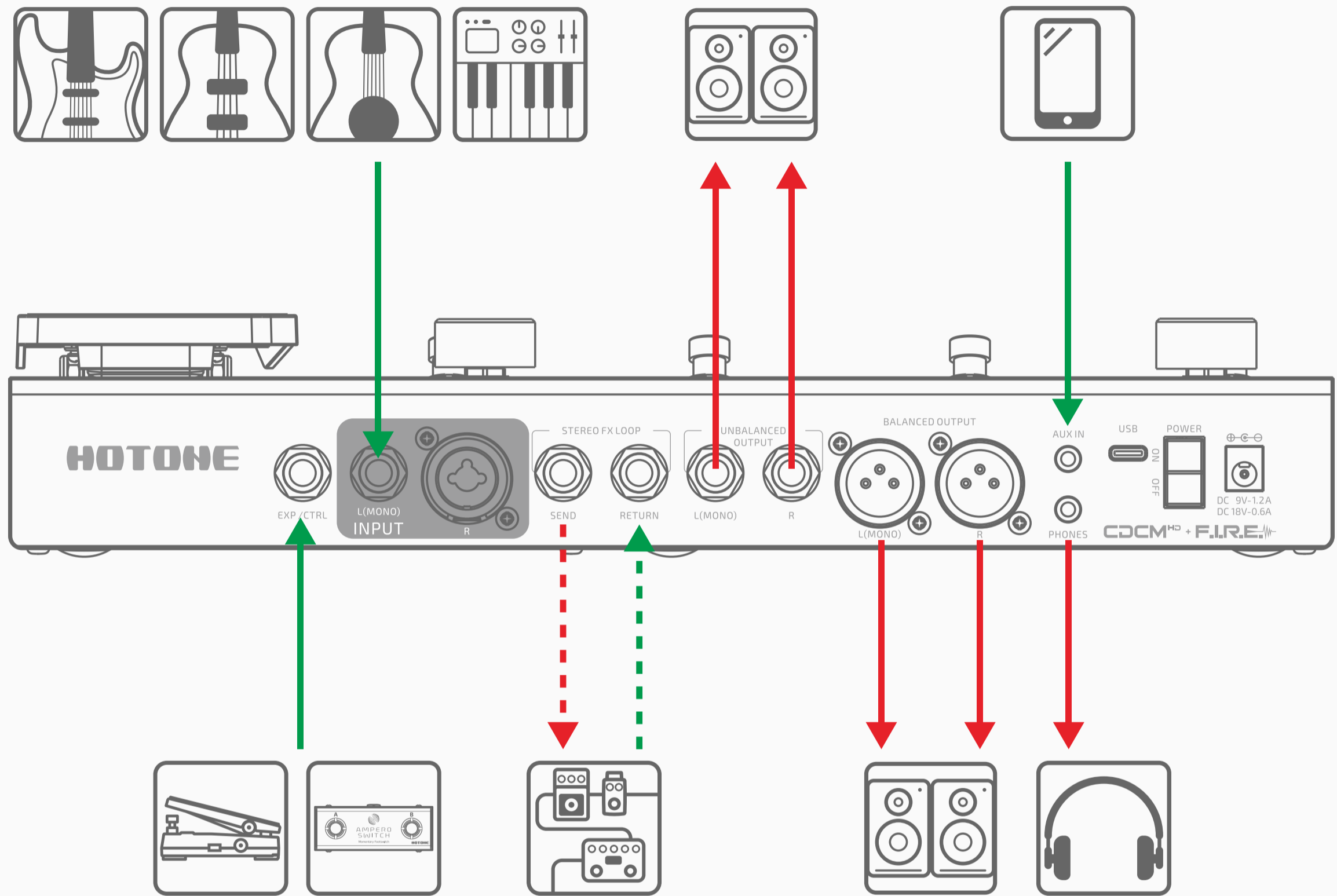

» The Editor

Connect Ampero II to your computer and access the free software to manage your device, adjust tonal settings, transfer files, update firmware, and upload third party IR files. Ampero II editor is compatible with Windows and macOS platforms. Log on to www.hotone.com/support to download the free software.

» Troubleshooting

Device won't turn on

- Make sure the power supply is properly connected and the device is switched on.
- Check if the power adapter is working properly.
- Check if you're using the correct power adapter.

No sound or slight sound

- Make sure your cables are connected properly.
- Make sure the volume knob is adjusted properly.
- Make sure the POWER ON setting in GLOBAL - I/O menu is set to Normal.
- When the expression pedal is used for volume control, check its position and volume settings.
- Check the effects module volume settings.
- Check the patch volume settings.
- Make sure your input device is not muted.
- Make sure BAL. /UNBAL. /FX SND SOURCE in GLOBAL - I/O menu is set to Normal.
- If you're using a noise gate, please make sure the Side Chain parameter is correctly set to match the input jack you're using.

Noise

- Make sure your cables are connected properly.
- Check your instrument output jack.
- Check if you're using the correct power adapter.
- If the noise is coming from your instrument, try using the noise reduction module to adjust it.

Sound problems

- Make sure your cables are connected properly.

- Check your instrument output jack.
- If you're using an external expression pedal to control distortion or other similar parameters, check to see if the expression pedal is set up properly.
- Check your effects parameter setup. If effects are set to extremes, Ampero II may only emit noise.

FX loop problems

- Make sure FX SND/RTN/LOOP modules are added on effects chain.
- Make sure FX SND/RTN/LOOP module parameters and input/output nodes, global settings that related to FX loop jacks are set properly.
- When using stereo connection, a Y cable (one TRS jack to two TS jacks) is needed and should be wired as below:

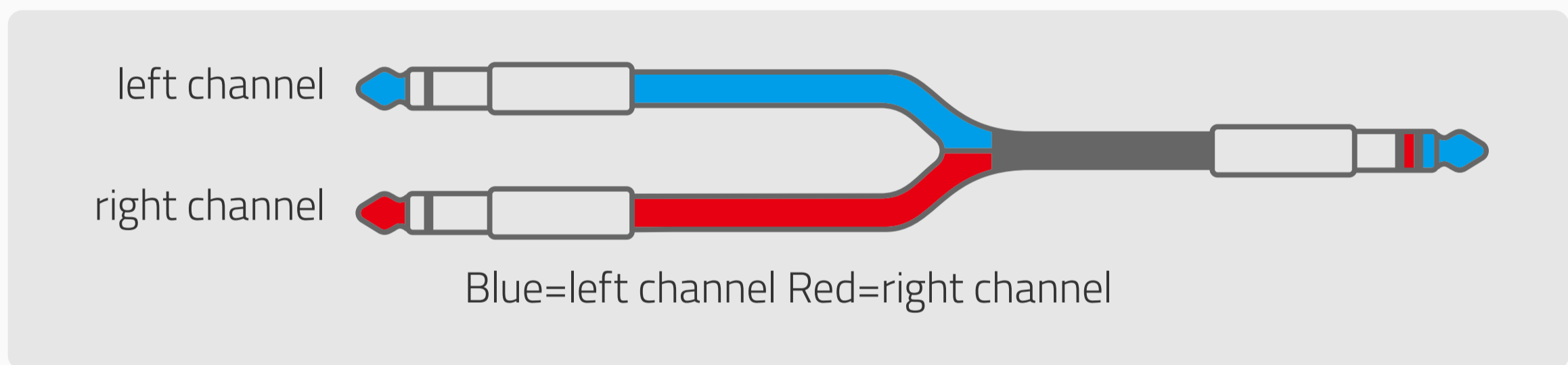

Problems with expression pedal

- Try calibrating the pedal.
- When using an external expression pedal, make sure you're using a 1/4" (6.35mm) male-to-male TRS cable.

» Technical Specifications

Effects Digital Audio Signal Processing: 24-bit depth, 44.1kHz sample rate

Frequency Response: 20Hz – 20kHz ± 1dB

Dynamic Range: Max. 127 dB (digital to analog)

Effects: 460+ (incl. global EQ)

No. of Effect Modules: 16

Effects Slots: Total of 12 simultaneous effects slots

Patches: 300

Looper Time: Stereo 60 seconds

Inputs:

- One 1/4" (6.35mm) Tip Sleeve (TS) instrument jack with 3 input mode selector
- One XLR or 1/4" (6.35mm) Tip Sleeve (TS) combo jack with 5 input mode selector and mic preamp (max. gain of 52dB)
- One 1/8" (3.5mm) Stereo Auxiliary In (Aux In) jack
- Two 1/4" (6.35mm) Tip Ring Sleeve (TRS) expression pedal/momentary footswitch input (EXP/CTRL) jacks
- One 1/4" (6.35mm) Tip Ring Sleeve (TRS) unbalanced stereo FX loop return jack
- One Standard 5 pin MIDI input jack

Outputs:

- Two 1/4" (6.35mm) Tip Ring Sleeve (TRS) unbalanced stereo output jacks
- Two XLR balanced stereo output jacks, with ground lift switch
- One 1/4" (6.35mm) Tip Ring Sleeve (TRS) unbalanced stereo FX loop send jack
- One 1/8" (3.5mm) stereo headphones output jack
- One Standard 5 pin MIDI output jack

Input Impedance:

- 1/4" (6.35mm) Tip Sleeve (TS) Input: E.GT: 1M Ω ; A.GT: 4.7M Ω ; LINE: 10k Ω
- XLR Input: 5k Ω
- FX Loop Return: 100k Ω
- Aux In: 10k Ω

Output Impedance:

- Unbalanced Output: 1k Ω
- Balanced Output: 1k Ω
- FX Loop Send: 1k Ω
- Headphones: 47 Ω

Screen: 5" 800 x 480 Color Dynamic Display Touch Screen

USB Port: USB 2.0 Type-C port; Supports USB Audio 2.0; Supports 44.1 to 192kHz sample rate switching

IR Impulse Response/IR processing: Supports 24-bit/44.1kHz Mono WAV files, 1024 and 2048 points; Supports up to 50 user IRs

Power Requirements: 9-18V DC Center Negative

Current Consumption: 1.4A Max (9V DC)

Dimensions: 330mm(W) x 157mm(D) x 61mm(H)

Weight: 1695g